

TECHNICAL
MANUAL

ashirvad

by aliaxis

**FIRE PROTECTION
SYSTEMS**



BlazeMaster[®]
FIRE PROTECTION SYSTEMS

BlazeMaster is the registered mark of The Lubrizol Corporation.
The Lubrizol Corporation is a Berkshire Hathaway Company.



IS 16088



CM/L - 6200118590

Ashirvad by aliaxis Fire Protection Systems

BlazeMaster® CPVC pipes and fittings by Ashirvad are specifically designed for fire protection systems and approved for more applications than any other nonmetallic system.



ashirvad

by aliaxis



BlazeMaster[®]
FIRE PROTECTION SYSTEMS



Index

01

Certifications & Recognitions	06
Leadership you can trust	07
About Aliaxis	08
10 Assurances	10

02

Quality Control Procedures	13
Overview	14
Features and Benefits	15
Applications	16

03

Industry Standards and Guidelines	
Concealed Installations	17
Unfinished Basements with Exposed Solid	19
Air Plenums	22

04

Material Properties	
Pressure Rating	24
Dimensions Details	25

05

Design Data	
Sprinkler Head Temperature Ratings	26
Temperature/Pressure Rating	26
Hydraulic Design	26
Thermal Expansion and Contraction	27
Pipe Deflection	29

06

Handling and Installation

Underground Water Pressure Service	31
Installation	31
Backfilling	32
Loop Offset for Contraction	32
Outdoor Installations	33
Set and Cure Times	34
Estimating One-Step Solvent Cement Requirements	35
Hangers and Supports	35
Threaded Connections	36
Flanged Connections	36
Grooved Coupling Adapters	37
Penetrating Fire Rated Walls and Partitions	37
Earthquake Bracing	37
Installation Dos and Don'ts	38

07

Fittings and Dimensions	39
Warranty and Incompatibility	42
Reference Tables and Conversion Charts	43

Certifications and Recognitions

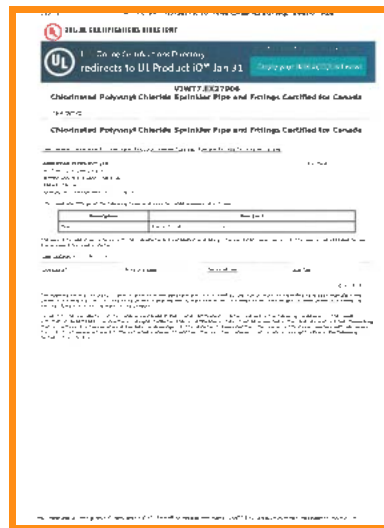
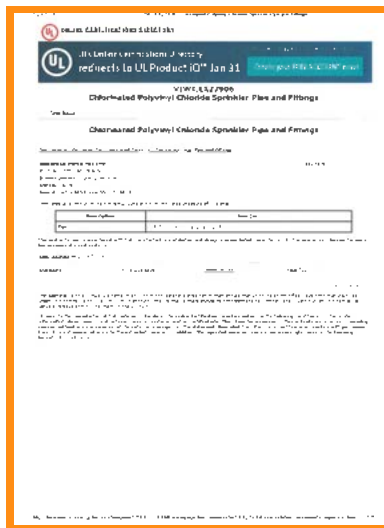
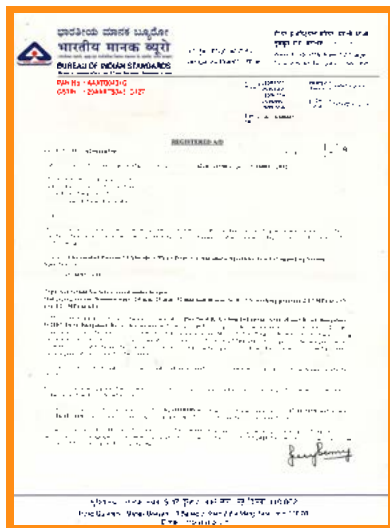

In 2007, Ashirvad won the National Award for "OUTSTANDING ENTREPRENEURSHIP IN MEDIUM ENTERPRISES"
The award was presented by the Prime Minister of India.



WRC Leaders Summit - 2014
Ashirvad Pipes
"One Of The 100 Fastest Growing Marketing Brands In Asia"
(Evaluated and selected by KPMG)
The Global Audit Firm



Construction Industry Database (CIDC) - 2016 Has been enlisted as an **Approved Vendor** for providing the following Services / Products
Manufacturing of
CPVC & uPVC Pipes & Fittings

Leadership you can trust

Ashirvad, an Aliaxis group company, setup its Bengaluru unit in 1998 and is a wholly owned company of Aliaxis group. Aliaxis group is a global leading manufacturer and distributor of plastic fluid handling systems used in residential, commercial and industrial buildings. Headquartered in Brussels, Belgium. Aliaxis is present in over 45 countries with more than 100 manufacturing and commercial entities, employs over 16,000 people and generates more than 3 billion Euro (INR 21, 600 crores approx.) in annual sales.

Ashirvad has always been relentless in its commitment to quality and service. Ashirvad is a leading manufacturer and supplier of CPVC, uPVC, SWR plumbing systems and is also the pioneer in designing and manufacturing uPVC column pipes, which are used in the erection of submersible bore-well pumps. Today Ashirvad is the world's largest manufacturer of uPVC column pipes and is also successfully exporting to over 40 countries. The CPVC Hot and Cold plumbing system is manufactured in collaboration with Lubrizol, USA (a Berkshire Hathaway company) and is best suited for the clean and hygienic supply of potable water. Ashirvad is the world's largest manufacturer of CPVC pipes and fittings.

Ashirvad expanded its product range with an innovative triple layer low noise (silent and silent plus) SWR and a foam core underground drainage system along with the widest range of locally manufactured specialty items and accessories such as – manholes, inspection chambers and non-return valves.

Ashirvad has a state of the art manufacturing facility with production capacity in excess of 2,00,000 M.T.p.a, man power strength of 3500+ across various functions and 17 ware houses pan India. In 2008 Ashirvad was presented with a national award by the Prime Minister of India for “Outstanding Entrepreneurship in Medium Enterprises”. It was also selected by KPMG in 2014 as “One of the 100 Fastest Growing Marketing Brands in Asia”. Ashirvad pipes has consistently grown year on year and aims to become a one stop shop for all plumbing, sanitary and drainage products in the country.

To provide safer and reliable fire protection systems for high-rise buildings, commercial buildings and individual homes, Ashirvad Fire Protection Systems introduces BlazeMaster® pipes and fittings which are made from chlorinated polyvinyl chloride (CPVC).

About Aliaxis



Aliaxis group is a leading global manufacturer and distributor of plastic fluid handling systems used in residential, commercial and industrial buildings.

Head quartered in Brussels, Belgium. Aliaxis is present in over 45 countries, has more than 100 manufacturing and commercial entities and employs over 16,000 people.

Aliaxis leverages local and global knowledge of the industry as well as regulations and building habits to provide consistently excellent customer service through distribution partners to builders, installers, infrastructure contractors and others. The group is in the Indian plumbing and sanitary market through a partnership with Ashirvad Pipes since 2013.

Aliaxis at a glance



€ 3.1 billion
Revenue



120+
Distribution centres



1.400+
Injection machines



16.000+
Colleagues



45+
Countries



600+
Extruders



€ 87 million
Capex



80+
Manufacturing sites



10
Commercial brands

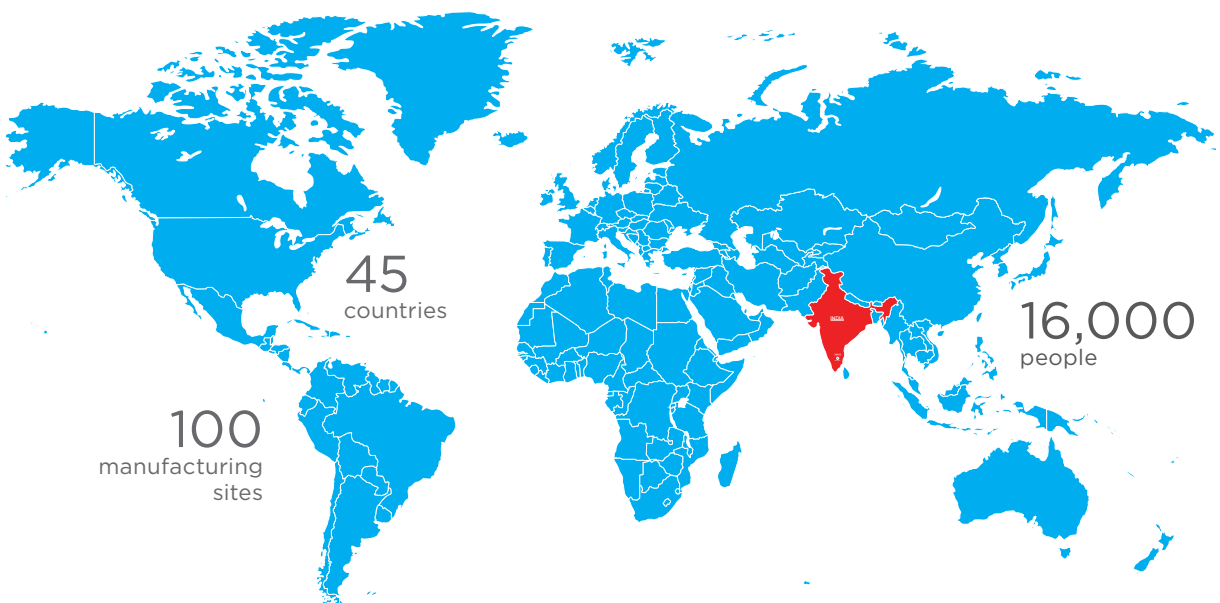



Step by step installation instruction



Step 1: Cutting



Step 2: Deburring/Beveling



Step 3: Solvent Cement Application



Step 4: Assembly



10 ASSURANCES

#01

STATE OF THE ART
MANUFACTURING FACILITIES

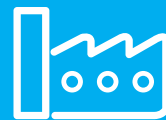

#02

ADVANCED MACHINERY
FOR SUPERIOR QUALITY

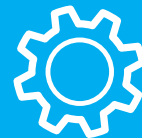

#03

ADVANCED MATERIAL
HANDLING SYSTEMS



#04

100% INCOMING RAW
MATERIAL INSPECTION

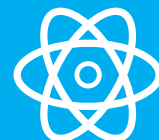

#05

HIGH DIMENSIONAL ACCURACY
TO MAINTAIN QUALITY OF
EACH PIECE, TO ENSURE
A DEFECT FREE SYSTEM



Ashirvad's stringent quality checks ensure premium products and maximum customer satisfaction

#06

STRINGENT QUALITY CHECKS AT EVERY LEVEL OF PRODUCTION

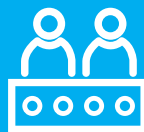

#07

100% FINISHED GOODS INSPECTION



#08

MULTIPLE QUALITY CHECKS IN PLACE FOR EVERY CPVC BRASS FITTING THAT LEAVES THE ASHIRVAD FACTORY



#09

EVERY BATCH OF PRODUCTS LAB TESTED



#10

REGULAR EXTERNAL LAB TESTING OF PRODUCTS IN USA, FRANCE AND INDIA

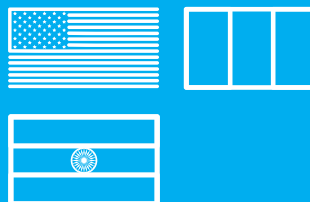

DELIVERING RELIABILITY FOR LIFE

SPECIFIED ACROSS THE GLOBE

Around the world, BlazeMaster® Fire Protection Systems are specified for High-rise Buildings, Schools, Office Buildings, Hotels, Healthcare Facilities, Libraries and Commercial Retrofits.



Quality Control Procedures at Ashirvad

Pipes and fittings manufactured at Ashirvad, follow a stringent quality control process before being rolled out into the market, in order to supply a defect free system to its users.

PIPES



Heat Reversion Test

How much the pipe changes in length when heated in an oven and left to cool. This is a measure of residual stresses left in the pipe during production process.



Hydrostatic Pressure Test

Short term (Acceptance Test): When subjected to internal hydrostatic pressure the pipe should not burst or crack at the given test pressure for minimum of 1 min. This pressure must be over 5 times the normal pressure rating.



Drop Impact Test

Weights are dropped on the pipe to observe for any cracks or failures.



Flattening Test

Samples are compressed so that opposite walls are brought together without the pipe cracking, which is a good measure of correct extrusion techniques during production.



Tensile Strength

The maximum stress that a pipe can withstand while being stretched or pulled.

Kinking test

The kinking resistance is a measure for the highest mechanical strain that a pipe tolerates. After conducting the test, test sample shall not kink (sharp twist/curve) at the minimum Bending radius values.

FITTINGS



Stress Relief Test

To determine the level of internal stress by heating the fitting in an air-circulated oven @ 150°C. There should not be any blisters, weld line splitting or any cracking.

Ten day moist ammonia air stress crack test

After 10 days brass part containing more than 15% zinc shall show no evidence of cracking when examined using 25X magnification

PIPES AND FITTINGS



Burst Pressure Check

Maximum pressure before the fittings burst. This must be over three times the normal pressure rating.



Visual Appearance

To ensure that all pipes and fittings are uniform in colour and free visual effects such as black dots, scratches, burn marks, etc.



Dimensions

To ensure that all pipes and fittings conform to the appropriate standards.



Opacity

To measure the percentage of light flux passing through the wall and to ensure it is below 0.2%.



Vicat Softening Temperature

The temperature at which 1 mm² needle penetrates 1 mm through the wall of the pipe.



Density

Density of pipes and fittings is to be determined.

Fire Exposure Test

CPVC pipes and fittings shall be fire tested for 10 min and during the fire testing pipe and fittings assemblies shall not burst, separate or leak and shall maintain the sprinkler in the intended operating position.

Flammability Test

To check V-0 rating of CPVC pipes & fitting, ie: to check the ability of the pipe/fittings to burn or ignite, causing fire or combustion.

Flexural Strength (Bend strength)

To check the stress in a pipe just before it yields in a flexure test. Piping joints shall sustain a bending moment equivalent to twice weight of the water filled pipe over twice the hanger spacing distance without kinking, leaking or other sign of permanent damage

Vibration Test

Pipe & fitting assemblies shall withstand the effects of vibration minimum for 30h.

Long term (Type Test)

The pipes and fittings assembly should not crack or burst at the given test pressure for a period of 1000 hours at 65°C

Overview

This manual provides the most up-to-date and comprehensive information about BlazeMaster® pipes & fittings by Ashirvad. All aspects of the BlazeMaster® System are covered from basic raw material properties to installation procedures of the finished product. Written with the engineer, contractor and distributor in mind, it is based on laboratory test results combined with Ashirvad's years of field experience.



Technical Details

Nominal Size		Kilo grams / mtr	
inches	mm	Empty	H ₂ O filled
¾	20.0	0.250	0.637
1	25.0	0.390	1.000
1¼	32.0	0.622	1.606
1½	40.0	0.816	2.109
2	50.0	1.278	3.310
2½	65.0	1.871	4.844
3	80.0	2.778	7.186

BlazeMaster® pipes by Ashirvad are UL listed. UL approved Fittings and solvent cement are imported from Ashirvad's sister company IPEX in Canada.

BlazeMaster® is the registered trademark of the Lubrizol Corporation or its affiliates. The Lubrizol Corporation is a Berkshire Hathaway Company.

Features and Benefits

BlazeMaster® by Ashirvad Fire Protection Products are designed specifically for fire protection systems. They are made from a specialty thermoplastic known as post-chlorinated polyvinyl chloride (CPVC). It provides unique advantages in sprinkler installations including superior hydraulics, the ease of joining, increased hanger spacing in comparison to other thermoplastics. They also are based on a technology with a continuous and proven service history of more than 40 years.

Lower Installation Cost

In addition to lower material cost, it can significantly reduce labour and transportation costs on a typical installation. The main reasons plastics are easy to handle, store, cut and joint. And heavy equipments are required to install metal and other piping systems.

Extended Life

BlazeMaster® pipes and fittings by Ashirvad are ageless and impervious to normal weather. BlazeMaster® systems are providing quality service for over 18 years. During maintenance or revisions, examinations of the original plastic materials showed excellent physical and hydraulic characteristics. Once properly selected for the application and correctly installed, it provides years of maintenancefree service. Our materials will not rust, pit, scale or corrode on either interior or exterior surfaces.



Improved Flow

Ashirvad piping has a substantially lower Roughness Factor than metal and other materials, and since BlazeMaster® CPVC by Ashirvad does not rust, pit, scale or corrode, the interior walls remain smooth in virtually any service. This high carrying capacity may result in the use of flatter grades or smaller diameter pipe.

Fire Performance

BlazeMaster® pipes by Ashirvad are made of CPVC which offers an even greater fire safety profile than PVC. Like PVC, CPVC will not independently support combustion, and as such will not burn once the flame source is removed. CPVC's ignition resistance is demonstrated by its flash ignition temperature of 900°F. CPVC also has a low flame spread.

Combining it with other CPVC and Solvent Cements

BlazeMaster® pipes by Ashirvad are UL listed and UL approved fittings, solvent cement are imported from Ashirvad's sister company IPEX in Canada.

BlazeMaster® CPVC fittings by Ashirvad compatibility have not been evaluated for UL Listing.

All BlazeMaster® Fire Protection Products by Ashirvad are UL & C-UL listed for use in systems containing other manufacturers' BlazeMaster® CPVC products UL & C-UL Listed in accordance with the appropriate requirements.

Note: While BlazeMaster® Fire Protection Products by Ashirvad are UL Listed for use in combination with other listed manufacturers' products, specific application approvals may not be the same among manufacturers. It is the installer's responsibility to verify suitability of products used in combination according to each manufacturer's installation instructions. Contact individual manufacturers if you have questions on specific applications.

The BlazeMaster® products' listing does not include the combination of BlazeMaster® CPVC pipe with other types of specially listed CPVC fire protection pipes, fittings and solvent cements.

Applications

The pipes and fittings offers superior performance that exceeds your requirements:

- Field fabrication reduces design engineering
- Smooth inner surface allows pipe downsizing with superior hydraulics – Hazen-Williams “C” factor of 150
- Higher occupancy rate compared to metal retrofits
- Less impact on occupants during retrofits
- Design savings

Where It Can be Used?

BlazeMaster® by Ashirvad CPVC Fire Protection Products are Listed by Underwriters Laboratories (UL & C-UL) for use in:

- Light Hazard occupancies as defined in the Standard for Installation of Protection Systems, NFPA 13 (regardless of the height of the building).
- Residential occupancies as defined in the Standard for Installation of Protection Systems in Residential Occupancies up to Four Stories in Height, NFPA 13R.
- Residential occupancies as defined in the Standard for Protection Systems in One and Two Family Dwellings and Manufactured Homes, NFPA 13D.
- Air plenums, as defined by the Installation of Air Conditioning and ventilating Systems, NFPA 90A.
- Installation of Private Fire Service Mains and Their Appurtenances, NFPA 24.
- System risers in residential buildings up to four stories in height, NFPA 13R and 13D.
- See UL Fire Protection Equipment Directory, categories VIWT and HFYH.
- BlazeMaster® fire protection system's listings can change. For a current list log on to BlazeMaster.com.

BlazeMaster® by Ashirvad Fire Protection systems shall be employed in wet-pipe systems. (A wet-pipe system contains water and is connected to a water supply so that the water will discharge immediately when the Sprinkler bulb is bursted)

BlazeMaster® CPVC pipe and fittings by Ashirvad must never be used in a system using compressed air or other gases.

National Fire Protection Association Standards 13, 13R, 13D, and NFPA 24 must be referenced and followed for design and installation requirements in conjunction with this design manual.

Light Hazard Installations.

NFPA 13 (2019 Edition)

- Pipe or tube listed for light-hazard occupancies shall be permitted to be installed in ordinary-hazard rooms of otherwise light-hazard occupancies where the room does not exceed 400 ft² (37 m²).
- Pipe or tube installed in accordance with above shall be permitted to be installed exposed, in accordance with their listing.
- Where nonmetallic pipe is installed in accordance with the above supplies sprinklers in a private garage within a dwelling unit not exceeding 1000 ft² (93 m²) in area, it shall be permitted to be protected from the garage compartment by not less than the same wall or ceiling sheathing that is required by the applicable building code.

NFPA 13R (2019 Edition)

- Pipe or tube listed for light-hazard occupancies shall be permitted to be installed in ordinary-hazard rooms of otherwise light-hazard occupancies where the room does not exceed 400 ft² (37 m²).
 - Pipe or tube installed in accordance with above shall be permitted to be installed exposed, in accordance with their listing.
- Pipe or tube listed for light-hazard occupancies shall be permitted to be installed above ordinary-hazard rooms under the following conditions:
 - In rooms 400 ft² (37 m²) or less, piping shall be permitted to be installed either exposed in accordance with its listing or installed concealed behind a minimum of one layer of 3/8 in. (10 mm) thick gypsum wallboard or 1/2 in. (13 mm) thick plywood.
 - In rooms over 400 ft² (37 m²) piping shall be permitted to be installed concealed behind a minimum of one layer of 3/8 in. (10 mm) thick gypsum wallboard or 1/2 in. (13 mm) thick plywood.

Industry Standards and Guidelines

Concealed Installations

With concealed installation the minimum protection shall consist of one layer of 3/8" (9.5 mm) gypsum wallboard, or a suspended membrane ceiling with lay-in panels or tiles having a weight of not less than 0.35 pounds per square foot (1.7 kg per square meter) when installed with metallic support grids, or 1/2" (12.7 mm) plywood soffits.

For residential occupancies the minimum protection may consist of one layer of 1/2" (12.7 mm) plywood. During periods of remodeling and renovation, appropriate steps must be taken to protect the piping from fire exposure if the ceiling is temporarily removed.

In concealed installation, the sprinkler temperature rating is 107°C (225°F) or lower. The effectiveness of this protection can be impaired if penetrated by large openings such as ventilation grills; exhaust fans connected to metal ducts serving washrooms excepted. Where such penetration is present, individual openings exceeding 0.03 m² but not exceeding 0.71 m² in area must be located so that the distance from the edge of the opening to the nearest sprinkler does not exceed 300 mm. This piping shall not be used where such openings exceed 0.71 m² in area. The effect of the presence of non-rated recessed lighting fixtures, public address speakers and other interruptions of the protective membrane has not been investigated.

Installation in Concrete

BlazeMaster® pipes & fittings by Ashirvad are acceptable for use embedded in concrete. Direct contact with concrete does not have any adverse chemical effect on BlazeMaster® materials. The following installation practices shall be followed.

1. As the BlazeMaster® pipe by Ashirvad is laid out it shall not come into contact with sharp objects or edges, such as rocks, metal, or structural members. Any open pipe ends shall be protected from debris or concrete getting into the system.
2. When laying out the pipe it is best to use straight runs of pipe. However, CPVC pipe is inherently ductile and it is possible for CPVC pipe to be snaked when it is laid out. This can be useful in some installations

when some offset from a straight run can be helpful in avoiding various construction obstacles. Straight runs of pipe will minimize any stress that is exerted on the pipe. When the pipe is embedded in concrete there is not opportunity to relieve any stress once the concrete is poured. Therefore, it is important to layout the piping such that the stress is minimized from the time of installation (see Pipe Deflection section for allowable deflection).

3. Avoid the contact of pipe and fittings with construction materials that are incompatible with CPVC. Verify the suitability of a product for use with CPVC with the manufacturer of the chemical additive to confirm chemical compatibility.

BlazeMaster® pipes & fittings by Ashirvad have been successfully installed encased in concrete for many years. Lubrizol is unaware of any problems that have been caused by chemical incompatibility between BlazeMaster® Fire Protection Products and concrete or any chemicals that have been added to concrete. Since new construction materials are regularly introduced to the market, however, you may have questions regarding the compatibility of the products you're using. To help ensure a successful installation, Lubrizol recommends contacting the manufacturer of the chemical to confirm chemical compatibility.

4. Steps must be taken to prevent the wire mesh or reinforcing bars from causing any abrasion damage to the BlazeMaster® pipes & fittings by Ashirvad (see Handling and Storage section). This is mostly of concern prior to pouring the concrete. BlazeMaster® Products shall not be installed in concrete that is to be post tensioned. The post tensioning process can create excessive forces which can damage the BlazeMaster® Fire Protection Products.
5. When there are pipe joints that will be covered in concrete, the installation shall be pressure tested prior to pouring the concrete. If there will not be any joints covered by concrete, there is no need to pressure test the system prior to pouring the concrete.

6. Prior to the pouring of the concrete, the BlazeMaster® pipe by Ashirvad shall be intermittently secured to prevent movement during this process. Nonabrasive, plastic fasteners are good choices for this application. When hangers are used, most metal hangers designed for metal pipe are suitable for BlazeMaster® pipe by Ashirvad. Do not use undersized hangers. Hangers with sufficient load bearing surface shall be selected based on pipe size, i.e., 1." (38 mm) hangers for 1." (38 mm) pipe. The hanger shall not apply compressive load or have rough or sharp edges that come into contact with the pipe.
7. Care shall be taken so that the BlazeMaster® pipes & fittings by Ashirvad are not damaged by the tools and equipment used to pour and finish the concrete. All standard methods of pouring concrete onto the ceiling construction with concrete pumps or concrete containers followed by compaction with vibrators can be used in combination with BlazeMaster® pipes & fittings by Ashirvad Products shall not come into contact with equipment such as tampers and agitators.
8. As the concrete is poured, assure that the pipe has not moved from its intended positioning.
9. Thermal expansion and contraction is not an issue for BlazeMaster® Fire Protection Products by Ashirvad that are embedded in concrete. Those forces are relieved in a manner that does not affect the pipe or fittings. However, expansion and contraction shall be incorporated in the design of those sections of pipe that are not embedded in concrete. Failure to adequately allow for stress at these points may result in damage to the pipe where it enters and exits the concrete.

Note: It is recommended that when transitioning from embedded to not embedded in concrete that 6" (150 mm) of 1" (25 mm) compatible foam pipe insulation be installed around the embedded pipe.

Exposed Installations (Where Sprinklers are Required)

Note: It is always acceptable to install products in areas where sprinklers are not required. Refer to the manufacturer's installation instructions.

As an alternative to the protection requirements, BlazeMaster® Fire Protection

Products by Ashirvad may be installed without protection (exposed) when subject to the following additional limitations:

A. Standard Coverage and Residential Sprinklers

These installations shall be below a smooth, flat, horizontal ceiling construction and require the use of BM-5, FP-1000 or TFP-500 one step solvent cement.

1. Light Hazard or Residential Pendent Sprinklers

Listed quick response, 170°F (77°C) maximum temperature rated, pendent sprinklers having deflectors installed within 8" (203 mm) from the ceiling or Listed residential, 170°F (77°C) maximum temperature rated, pendent sprinklers located in accordance with their Listing and a maximum distance between sprinklers not to exceed 15' (4.57 m). The piping shall be mounted directly to the ceiling.

2. Light Hazard or Residential Horizontal Sidewall Sprinklers

Listed quick response, 200°F (93°C) maximum temperature rated, horizontal sidewall sprinklers having deflectors installed within 12" (304 mm) from the ceiling and within 6" (150 mm) from the sidewall or Listed residential, 200°F (93°C) maximum temperature rated, horizontal sidewall sprinklers located in accordance with their Listing and a maximum distance between sprinklers not to exceed 14' (4.27 m). The piping shall be mounted directly to the sidewall.

3. Light Hazard Upright Sprinklers

Listed quick response, 155°F (68°C) maximum temperature rated, upright sprinklers having deflectors installed within 4" (101 mm) from the ceiling and a maximum distance between sprinklers not to exceed 15' (4.57 m). The maximum distance from the ceiling to the centerline of the main run of pipe shall not exceed 7 1/2" (190 mm) and the distance from the centerline of a sprinkler head to a hanger shall be 3" (76 mm).

B. Light Hazard Extended Coverage & Residential Sprinklers

These installations shall be below a smooth, flat, horizontal ceiling construction, are limited to unobstructed construction, require the use of Schedule 80 fittings for sizes 38.1 mm and greater, and require the use of BM-5, FP-1000, or TFP-500 one step solvent cement. For pendent sprinkler installations, the piping shall be mounted directly to the ceiling. For horizontal sidewall sprinkler installations, the piping shall be mounted directly to the sidewall.

1. Light Hazard Extended Coverage or Residential Pendent Sprinklers

Listed light hazard, extended coverage, quick response, 155°F (68°C) maximum temperature rated, pendent sprinklers having deflectors installed within 8" (203 mm) from the ceiling, a maximum distance between sprinklers not to exceed 20' (6.09 m), and an application density not less than 0.10 gpm/ft² (4.08 ml/min). Listed residential, 155°F (68°C) maximum temperature rated, pendent sprinklers having deflectors installed within 8" (203 mm) from the ceiling, a maximum distance between sprinklers not to exceed 20' (6.09 m), and an application density not less than 0.10 gpm/ft² (4.08 ml/min).

2. Light Hazard Extended Coverage or Residential Horizontal Sidewall Sprinklers

Listed light hazard, extended coverage, quick response, 175°F (79°C) maximum temperature rated, horizontal sidewall sprinklers having deflectors installed within 12" (304 mm) from the ceiling and within 6" (152 mm) from the sidewall, a maximum distance between sprinklers not to exceed 16' (4.87 m), and an application density not less than 0.10 gpm/ft² (4.08 ml/min).

Listed residential, 165°F (74°C) maximum temperature rated, horizontal sidewall sprinklers having deflectors installed within 12" (304 mm) from the ceiling and within 6" (152 mm) from the sidewall, a maximum distance between sprinklers not to exceed 18' (5.48 m), and an application density not less than 0.10 gpm/ft² (4.08 ml/min).

Listed light hazard, extended coverage, quick-response, 165°F (74°C) maximum temperature rated, horizontal sidewall sprinklers having deflectors installed within 12" (304 mm) from the ceiling and within 6" (152 mm) from the sidewall, a maximum distance between sprinklers not to exceed 18' (5.48 m), and an application density not less than 0.10 gpm/ft² (4.08 ml/min).

Listed light hazard, extended coverage, quick response, 155°F (68°C) maximum temperature rated, horizontal sidewall sprinklers (manufactured by Reliable Automatic Sprinkler Co Inc, SIN RA0362) having deflectors installed within 12" (304 mm) from the ceiling and within 6" (152 mm) from the sidewall, a maximum distance between sprinklers not to exceed 24' (7.31 m), and a flow not less than 40 gpm (152 L/min) per sprinkler.

Unfinished Basements

Note: Check with your Ashirvad representative or local building code for use of system before installing in unfinished basements.

1. BlazeMaster® CPVC pipe and fittings by Ashirvad can be installed without protection (exposed) in unfinished basements in accordance with NFPA 13D when subject to the following additional limitations:

The ceiling shall be horizontal and constructed utilizing solid wood joists OR composite wood joists with a nominal depth of 16" (406 mm) or less on maximum 24" (610 mm) centers.

2. The distance from the floor to the bottom of the solid wood joists shall be between 7' (2.13 m) and 10' (3.04 m).
3. Listed residential pendent sprinklers with a maximum temperature rating of 155°F (68°C) and a minimum K-factor of 4.9 are to be used for this type of installation. The maximum sprinkler spacing shall not exceed 16' (4.87 m). Lesser areas are also permitted. The system is to be designed based upon the Listed flows for the sprinkler selected except that the flow for a single sprinkler or for multiple sprinklers flowing is to be not less than 13 gpm (49 Lpm) per sprinkler. The sprinklers are to be installed with their deflectors a maximum of 13/4" (44.5 mm) below the bottom of the joists in anticipation of future installation of a finished ceiling (reference NFPA 13D, Section 8.2.4, 2019 Edition).
4. All system mains shall be run perpendicular to the joists. All branch lines shall be run parallel to the joists. Schedule 80 fittings in the 1-1/2 in. and larger size shall be used.
5. All solvent cement joints shall be made with BlazeMaster® (BM-5) One Step Solvent Cement by Ashirvad.
6. The maximum length along the joist shall not exceed 40' (12.2 m). When the length exceeds 40' (12.2 m), blocking shall be utilized. The blocking shall be constructed of minimum 1/2" (12.7 mm), minimum 3/8" (9.5 mm) gypsum wallboard or batt insulation with a minimum thickness of 31/2" (88.9 mm). These blocking materials shall be the full depth of the joists. When batt insulation is used as blocking, it must be a single piece of insulation. The insulation must be secured in place with metal wire netting which must encase the insulation on

both of the exposed sides. The metal wire netting is required to hold the insulation in place and prevent it from being dislodged or repositioned over time. It is acceptable for items such as piping, wires, ducts, etc. to penetrate the blocking. The gap between the item penetrating the blocking and the blocking should be minimized. For installations where the gap exceeds 1/4" (6.4 mm), the gap shall be filled with insulation, caulking, or other suitable material.

7. When installing Ashirvad BlazeMaster® CPVC pipe by Ashirvad perpendicular (system mains) to the joists, support devices for thermoplastic sprinkler piping or other support devices shall be used which mount the piping directly to the bottom of the joists. As an alternative to mounting the pipe and fittings below the solid wood joists, it is also acceptable to cut holes in the joists at or below the center of the depth of the joist for support - the holes should be oversized to allow for movement and located to not impair the structural integrity of the joists.

CAUTION: When drilling holes in the joists, the structural integrity must be maintained. Consult the Authority Having Jurisdiction (AHJ) or building code for requirements.

8. When installing Ashirvad BlazeMaster® CPVC pipe by Ashirvad parallel (branch lines) to the joists, the pipe and fittings shall be installed in the cavity below the bottom of the ceiling and above the bottom of the joist. The branch lines shall be located at or below the center of the depth of the solid wood joist. The pipe shall be installed utilizing support devices for thermoplastic sprinkler piping or other support devices which mount the piping directly to nominal 2" wood blocking or support devices for thermoplastic sprinkler piping which offset the pipe a nominal distance of 1½ in. from the joists.

Use of BlazeMaster® Fire Sprinkler Products by Ashirvad is limited to basements where the quantity and combustibility of contents is low and fires with relatively low rates of heat release are expected.

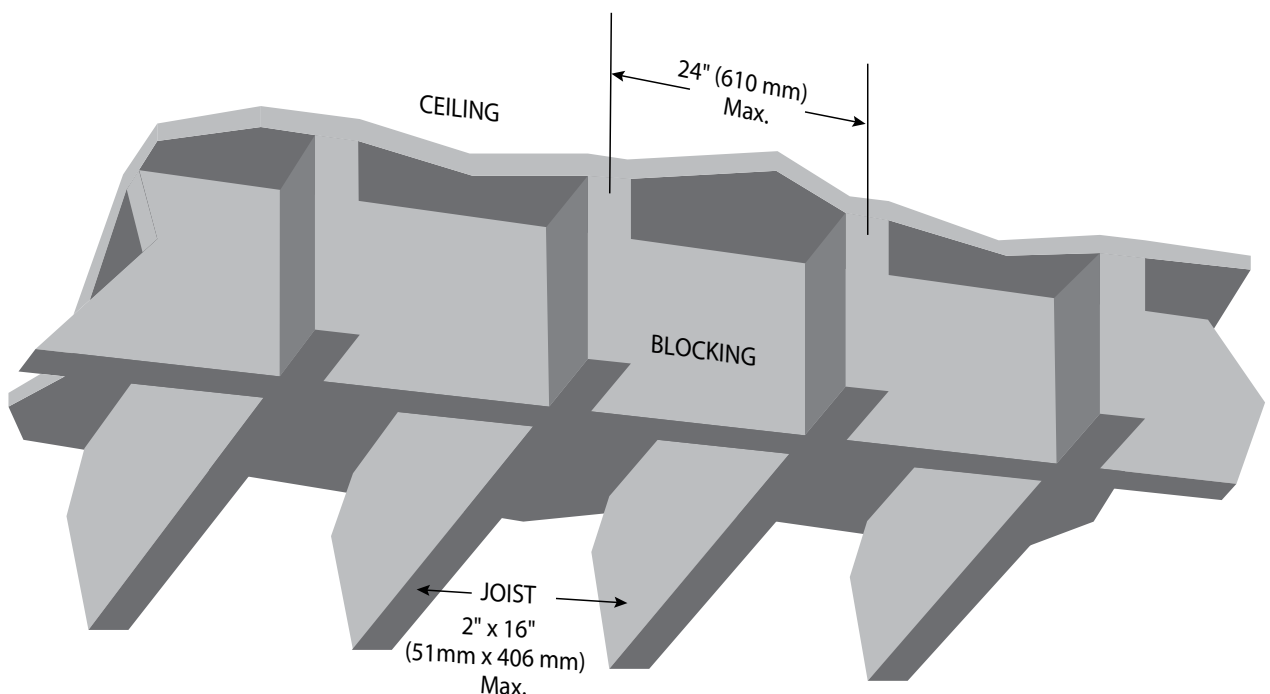

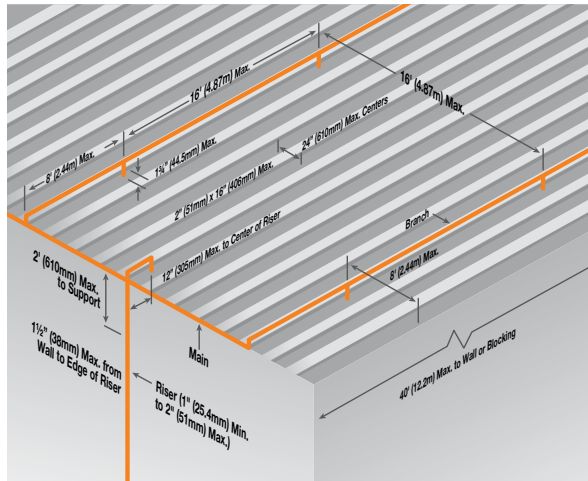

Center Wall Riser with Main at Wall

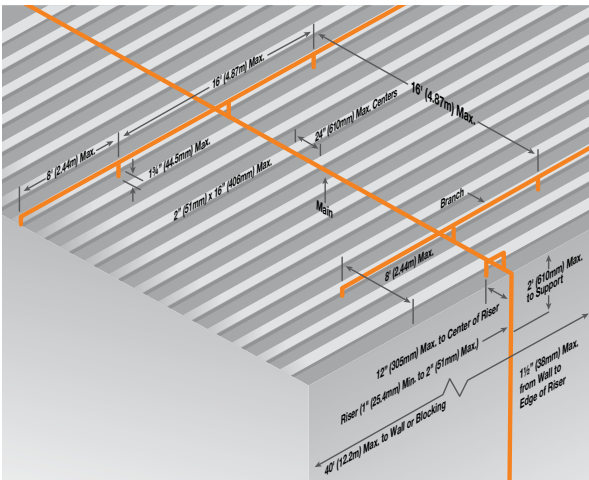

Center Wall Riser with Center Room Main

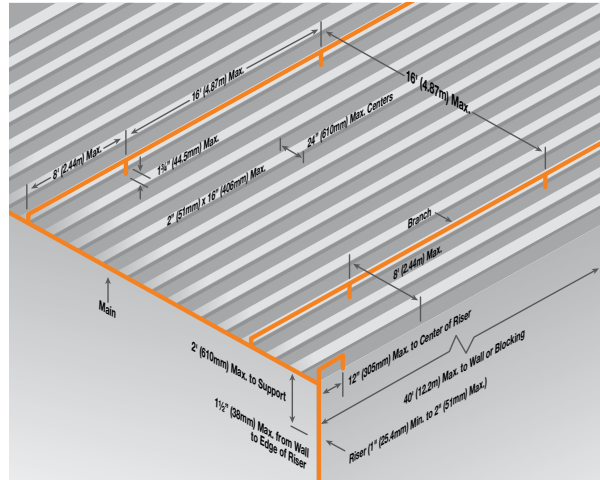

Riser in Corner

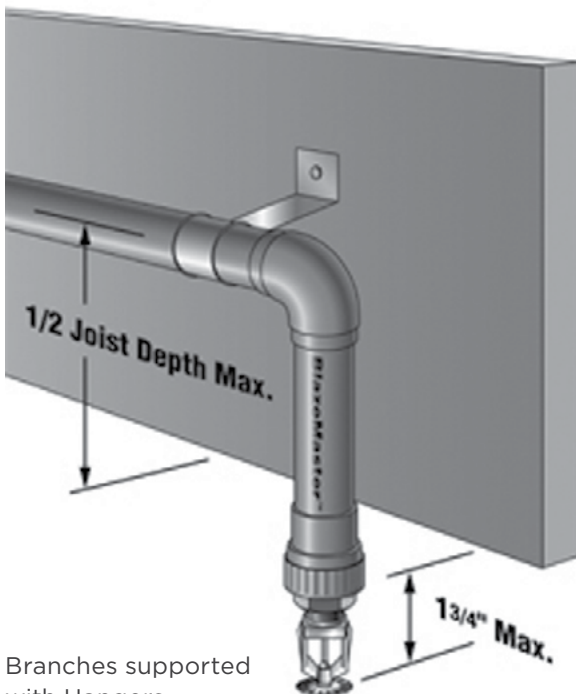

Branches supported with Hangers

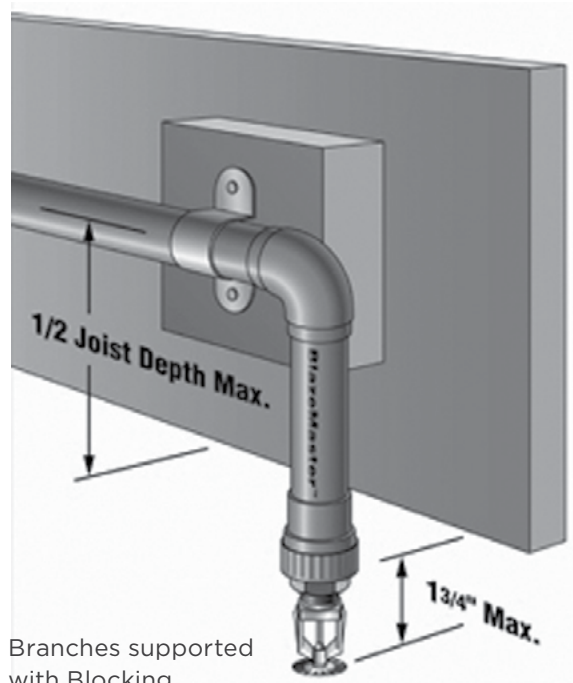

Branches supported with Blocking

Air Plenums

BlazeMaster® pipe and fittings by Ashirvad are approved for use in air plenums. BlazeMaster® pipe and fittings by Ashirvad have been investigated by UL per the requirements of UL 1887 and found to comply with the combustibility requirements for thermoplastic protection pipe as described in the Standard for Installation of Air Conditioning and Ventilating Systems, NFPA 90A and various model mechanical codes.

Note: BlazeMaster® pipe and fittings by Ashirvad may be installed in the plenum adjacent to, but not over, an opening in the ceiling such as ventilation grills.

System Risers in NFPA 13, 13R and 13D Applications

BlazeMaster® CPVC pipe and fittings by Ashirvad may be used as system risers in accordance with NFPA 13, 13D and 13R when subject to the following limitations:

1. When installed protected (concealed), the minimum protection shall consist of either one layer of 3/8" (9.5 mm) thick gypsum wallboard or 1/2" (12.7 mm) thick plywood.

2. When installed without protection (exposed), the following limitations shall apply:

Note: Only NFPA 13R and 13D applications may be installed without protection exposed).

a) The riser shall be installed below a smooth, flat, horizontal ceiling construction. A Listed residential pendent protection is to be installed with its deflector at the distance from the ceiling specified in the protection Listing.

OR

The riser shall be installed below a horizontal unfinished basement ceiling (in accordance with NFPA 13D) constructed utilizing solid wood joists OR composite wood joists with a nominal depth of 16" (406 mm) or less on maximum 24" (610 mm) centers.

A Listed residential pendent sprinkler is to be installed with its deflector a maximum of 13/4" (44.5 mm) below the bottom of the solid wood joist OR composite wood joist in anticipation of future installation of a finished ceiling.

b) A Listed residential pendent sprinkler is to have a maximum temperature rating of 155°F (68°C) and a minimum K-factor of 4.9 and is to be installed at a maximum horizontal distance of 12" (304.8 mm) from the centerline of the riser. The system is to be designed based upon the Listed flows for the sprinkler selected except that the flow for a single sprinkler or for multiple sprinklers flowing is to be not less than 13 gpm (49 Lpm) per sprinkler.

c) The riser shall be supported vertically within 2' (610 mm) of the ceiling or bottom of the joist.

d) The minimum riser diameter shall be 1" (25.4 mm) and the maximum riser diameter shall be 2" (50.8 mm).

e) The maximum distance between the wall(s) and the outside surface of the riser pipe shall be 1 1/2" (38 mm).

f) All solvent cement joints shall be made with BlazeMaster® One Step Solvent Cement by Ashirvad (TFP-500, FP-1000 and BM-5).

g) The instructions shown here for Exposed System Risers require the use of Schedule 80 fittings when riser sizes are 1 1/2" (38 mm) and larger.

3. The system shall be installed per the requirements of NFPA 13, Sections 17.4 (2019 Edition), Support of Risers.
4. The BlazeMaster® CPVC protection pipe and fittings by Ashirvad shall be installed per the manufacturer's installation and design manual.
5. Risers shall be supported by pipe clamps or by hangers located on the horizontal connection close to the riser. Only Listed hangers and clamps shall be used.
6. Vertical lines must be supported at intervals, described in 7 & 8 below, to avoid placing excessive load on a fitting at the lower end. Do this by using riser clamps or double bolt pipe clamps Listed for this service. The clamps must not exert compressive stresses on the pipe. It is recommended that the clamps should be located just below a fitting so that the shoulder of the fitting rests against the clamp. If necessary, a coupling can be modified and adhered to the pipe as a bearing support such that the shoulder of the fitting rests on the clamp. Follow the manufacturer's recommended cure time.

WARNING: Modified riser collar shall only be used to provide support to the riser and shall not be used to join two pieces of pipe.

7. Do not use riser clamps that squeeze the pipe and depend on compression of the pipe to support the weight.
8. Hangers and straps shall not compress, distort, cut or abrade the piping and shall allow for free movement of the pipe to allow for thermal expansion and contraction.
9. Maintain vertical piping in straight alignment with supports at each floor level, or at 10' (3.05 m) intervals, whichever is less.
10. CPVC risers in vertical shafts or in buildings with ceilings over 25' (7.62 m), shall be aligned straightly and supported at each floor level, or at 10' (3.05 m) intervals, whichever is less.



Material Properties

Pressure Rating

BlazeMaster® pipe and fittings by Ashirvad (20 – 80 mm (3/4" – 3")) are rated for continuous service of 2.17 MPa at 23° C and 1.21 MPa at 65° C.

Pipe Dimensions & Weights

Ashirvad BlazeMaster® pipe by Ashirvad is produced in SDR 13.5 dimensions. SDR, or standard dimensional ratio, means the pipe wall thickness is directly proportional to the outside diameter. This results in all diameters carrying the same pressure capability. Ashirvad BlazeMaster® pipe by Ashirvad is produced to the specifications of ASTM F 442 / IS 16088. Ashirvad BlazeMaster® fittings are produced to ASTM F 439 specifications depending on the size and configuration.

Basic Properties of BlazeMaster® CPVC by Ashirvad

Sl.No.	Property / Parameter	Test Method	Value / Result
--------	----------------------	-------------	----------------

General

1	Specific Gravity	ASTM D792	1.52
---	------------------	-----------	------

Mechanical

1	Izod impact strength (ft. lbs./inch, notched)	ASTM D256A	3.0
2	Ultimate Tensile Strength, psi	ASTM D638	8400
3	Modulus of Elasticity, @73°F,psi	ASTM D638	4.23 x 10 ⁵
4	Compressive strength, psi	ASTM D695	9600
5	Poisson's Ratio	-	0.35 - 0.38
6	Working Stress, @73°F,psi	ASTM D1598	2000
7	Hazen-Williams C Factor	-	150
6	Coefficient of Linear Expansion in./in.°F)	ASTM D696	3.4 x 10 ⁻⁵

Thermal

1	Thermal Conductivity BTU/hr./ft ² /°F/in	ASTM C177	0.95
---	---	-----------	------

Flammability

4	Limiting oxygen index	ASTM D2863	60%
---	-----------------------	------------	-----

Electrical

1	Electrical Conductivity	Non Conductor	
---	-------------------------	---------------	--

Dimension Details

Dimensional details and Pressure Ratings of SDR 13.5 (ASTM F 442) / IS 16088 BlazeMaster® CPVC Pipes by Ashirvad

Nominal Size (inch)	(mm)	Pr. Pressure at 65°C		Kilo grams /mtr Empty	Kilo grams /mtr H ₂ O filled
		(kg/cm ²)	(kPa)		
¾	20.00	12.3	1207	0.250	0.637
1	25.00	12.3	1207	0.390	0.100
1¼	32.00	12.3	1207	0.622	1.606
1½	40.00	12.3	1207	0.816	2.109
2	50.00	12.3	1207	1.278	3.310
2½	65.00	12.3	1207	1.871	4.844
3	80.00	12.3	1207	2.778	7.186

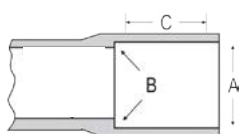

Tapered socket dimensions for BlazeMaster® CPVC Fittings by Ashirvad as per ASTM F 439

Nominal Size (mm)	Socket Entrance Diameter, inch (mm)		Socket Bottom Diameter, inch (mm)		Socket Length inch (mm)
	'A' Average	'A' Tolerance	'B' Average	'B' Tolerance	"C" min
20	26.87	±0.1	26.57	±0.1	25.4
25	33.66	±0.13	33.27	±0.13	28.58
32	42.42	±0.13	42.04	±0.13	31.75
40	48.56	±0.15	48.11	±0.15	34.93
50	60.63	±0.15	60.17	±0.15	38.10
65	73.38	±0.18	72.85	±0.18	44.45
80	89.28	±0.18	88.67	±0.18	47.63

Note: The above average OD and average ID information is per fitting standard IS 16088 / ASTM F439. Check with individual manufacturers for actual OD and ID information.

Design Data

Sprinkler Head Temperature Ratings

BlazeMaster® pipe and fittings by Ashirvad shall be used in protection systems employing sprinkler heads rated 107°C (225°F) or lower, for pendent and horizontal sidewall heads. Quick-Response upright heads shall be rated at 68°C (155°F) or less.

Temperature/Pressure Rating

BlazeMaster® pipe and fittings by Ashirvad (20 - 80 mm (3/4" - 3")) are rated for continuous service of 12.07 kg/cm² (175 psi) at 65°C (150°F). Ashirvad BlazeMaster® pipe and fittings are suitable for use in areas where ambient temperatures are within the range of 2°C (36°F) to 65°C (150°F). BlazeMaster® by Ashirvad pipe can be installed in an area, such as an attic, where the temperature will exceed 65°C (150°F) if ventilation is provided or if insulation is used around the pipe to maintain a cooler environment. BlazeMaster® piping systems must be laid out so that the piping is not closely exposed to devices that generate heat in excess of 65°C (150°F) such as light fixtures, ballasts and steam lines. If the installation is in an area subject to freezing temperatures, the protection system must be protected from freezing. A frozen system will not only be deactivated, but the pressures that may build up can cause the sprinkler heads to open or damage the pipes.

Hydraulic Design

C Factor

Hydraulic calculations for the sizing of BlazeMaster® pipe and fittings by Ashirvad shall be calculated using the Hazen-Williams C factor of 150.

Fittings Friction Loss

The following table shows the allowance for friction loss for fittings, expressed as equivalent length of pipe.

Allowance for Friction Loss in Fittings
(SDR 13.5 Equivalent Pipe)

		20mm (3/4")	25mm (1")	32mm (1 1/4")	40mm (1 1/2")	50mm (2")	65mm (2 1/2")	80mm (3")
Tee Branch	m (ft)	0.91 (3)	1.52 (5)	1.83 (6)	2.44 (8)	3.05 (10)	3.66 (12)	4.57 (15)
Elbow 90°	m (ft)	2.13 (7)	2.13 (7)	2.44 (8)	2.74 (9)	3.35 (11)	3.66 (12)	3.96 (13)
Elbow 45°	m (ft)	0.31 (1)	0.31 (1)	0.61 (2)	0.61 (2)	0.61 (2)	0.91 (3)	1.22 (4)
Coupling	m (ft)	0.31 (1)	0.31 (1)	0.31 (1)	0.31 (1)	0.31 (1)	0.61 (2)	0.61 (2)
Tee Run	m (ft)	0.31 (1)	0.31 (1)	0.31 (1)	0.31 (1)	0.31 (1)	0.61 (2)	0.61 (2)

Thermal Expansion and Contraction

BlazeMaster® CPVC pipe by Ashirvad like all piping materials, expands and contracts with changes in temperature. The coefficient of linear expansion is: 0.0000612 cm / cm °C (0.0000340 inch/inch-°F). Lineal expansion is the same for all pipe diameters.

Thermal Expansion in Inches

Formula: $\Delta L = L_p C (\Delta T)$
 Where: ΔL = change in length due to change in temperature in inches
 L_p = length of pipe in inches
 C = coefficient of thermal expansion 3.4×10^{-5} inch / inch °F
 ΔT = change in temperature °F

Example
 $L_p = 30 \text{ ft} = 360''$
 $\Delta T = 25^\circ\text{F}$
 $\Delta L = 360 \times 3.4 \times 10^{-5} (25)$
 $= 0.31''$

Temp Change $\Delta T^\circ\text{F}$	Length of Run in Feet													
	5	10	15	20	25	30	35	40	45	50	70	90	120	160
Thermal Expansion ΔL (in.)														
20	0.04	0.08	0.12	0.16	0.20	0.24	0.29	0.33	0.37	0.41	0.57	0.73	0.98	1.31
30	0.06	0.12	0.18	0.24	0.31	0.37	0.43	0.49	0.55	0.61	0.86	1.10	1.47	1.96
40	0.08	0.16	0.24	0.33	0.41	0.49	0.57	0.65	0.73	0.82	1.14	1.47	1.96	2.61
50	0.10	0.20	0.31	0.41	0.51	0.61	0.71	0.82	0.92	1.02	1.43	1.84	2.45	3.26
60	0.12	0.24	0.37	0.49	0.61	0.73	0.86	0.98	1.10	1.22	1.71	2.20	2.94	3.92
70	0.14	0.29	0.43	0.57	0.71	0.86	1.00	1.14	1.29	1.43	2.00	2.57	3.43	4.57
80	0.16	0.33	0.49	0.65	0.82	0.98	1.14	1.31	1.47	1.63	2.28	2.94	3.92	5.22
90	0.18	0.37	0.55	0.73	0.92	1.10	1.29	1.47	1.65	1.84	2.57	3.30	4.41	5.88
100	0.20	0.41	0.61	0.82	1.02	1.22	1.43	1.63	1.84	2.04	2.86	3.67	4.90	6.53

Thermal Expansion in Centimeters

Formula: $\Delta L = L_p C (\Delta T)$

Where: ΔL = change in length due to change in temperature in cm

L_p = length of pipe in cm

C = coefficient of thermal expansion 6.2×10^{-5} inch / inch °C

ΔT = change in temperature °C

Example

$L_p = 10$ Meters = 1000 cm

$\Delta T = 25^\circ\text{C}$

$\Delta L = 1000 \times 6.12 \times 10^{-5} (25)$
= 1.55 cm

Temp
Change

Length of Run in Meters

Δ T°F 1 2 4 6 8 10 12 14 16 18 20 30 40 50

Thermal Expansion ΔL (cm.)

10	0.06	0.12	0.24	0.37	0.49	0.61	0.73	0.86	0.98	1.10	1.22	1.84	2.45	3.06
15	0.09	0.18	0.37	0.55	0.73	0.92	1.10	1.29	1.47	1.65	1.84	2.75	3.67	4.59
20	0.12	0.24	0.49	0.73	0.98	1.22	1.47	1.71	1.96	2.20	2.45	3.67	4.90	6.12
25	0.15	0.31	0.61	0.92	1.22	1.53	1.84	2.14	2.45	2.75	3.06	4.59	6.12	7.65
30	0.18	0.37	0.73	1.10	1.47	1.84	2.20	2.57	2.94	3.30	3.67	5.51	7.34	9.18
35	0.21	0.43	0.86	1.29	1.71	2.14	2.57	3.00	3.43	3.86	4.28	6.43	8.57	10.71
40	0.24	0.49	0.98	1.47	1.96	2.45	2.94	3.43	3.92	4.41	4.90	7.34	9.79	12.24
45	0.28	0.55	1.10	1.65	2.20	2.75	3.30	3.86	4.41	4.96	5.51	8.26	11.02	13.77
50	0.31	0.61	1.22	1.84	2.45	3.06	3.67	4.28	4.90	5.51	6.12	9.18	12.24	15.30

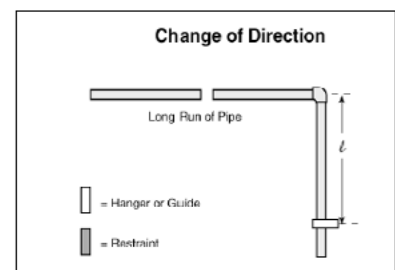
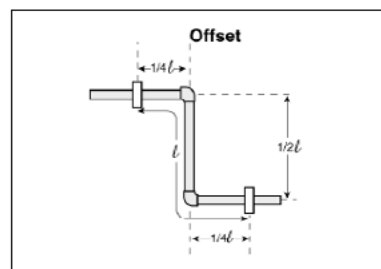
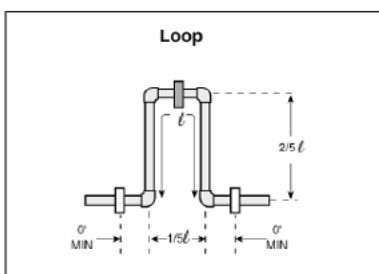

Pipe Deflection

BlazeMaster® fire protection piping by Ashirvad is inherently ductile allowing it to be deflected, within permissible limits, around or away from objects during installation, which can reduce installation time. This ductility allows for greater freedom of design and lower installed cost. The maximum installed deflections for BlazeMaster® piping are as follows:

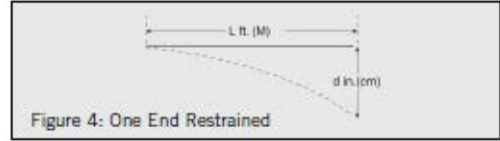

Maximum Installed Deflections (One End Restrained)

$$\text{Formula: } d = 0.329 \frac{L^2}{D}$$

Where: d = deflection in inches
L = length in feet
D = average outside diameter in inches (ref. Pg. 7)

Example

$$\begin{aligned} L &= 10 \text{ ft.} \\ D &= 2.375'' \text{ (for 2'' pipe)} \\ d &= 0.329 \times \frac{10^2}{2.375} \\ &= 0.329 \times \frac{100}{2.375} \\ &= 13.90 \end{aligned}$$

Pipe Size	Pipe Length in Feet													
Inches	2	5	7	10	12	15	17	20	25	30	35	40	45	50

Permissible Bending Deflections SDR 13.5 (73 °F) in Inches

¾	1.30	7.80	15.40	31.30	45.10	70.50	90.60	125.40	195.90	282.10	383.90	-	-	-
1	1.00	6.30	12.30	25.00	36.00	56.30	72.30	100.10	156.40	225.20	306.60	400.40	-	-
1¼	0.80	5.00	9.70	19.80	28.50	44.60	57.30	79.30	123.90	178.40	242.80	317.20	401.40	-
1½	0.70	4.30	8.50	17.30	24.90	39.00	50.10	69.30	108.20	155.90	212.20	277.10	350.70	433.00
2	0.60	3.50	6.80	13.90	20.00	31.20	40.00	55.40	86.60	124.70	169.70	221.70	280.60	346.40
2½	0.50	2.90	5.60	11.40	16.50	25.80	33.10	45.80	71.50	103.00	140.20	183.10	231.80	286.20
3	0.40	2.40	4.60	9.40	13.50	21.20	27.20	37.60	58.80	84.60	115.20	150.40	190.40	235.40

$$\text{Formula: } d = 228.472 \frac{L^2}{D}$$

Where: d = deflection in cm
L = length in meters
D = average outside diameter in mm (ref. Pg. 7)

Example

$$\begin{aligned} L &= 5 \text{ m.} \\ D &= 60.3 \text{ mm (for 50 mm pipe)} \\ d &= 228.472 \times \frac{5^2}{60.3} \\ &= 228.472 \times \frac{25}{60.3} \\ &= 94.70 \end{aligned}$$

Pipe Size	Pipe Length in Meters													
mm	1	2	3	4	5	6	7	8	9	10	11	12	13	14

Permissible Bending Deflections SDR 13.5 (23 °C) in cm

20	8.60	34.30	77.10	137.10	214.20	308.40	419.80	548.30	694.00	856.70	1036.70	-	-	-
25	6.80	27.40	61.60	109.50	171.00	246.30	335.20	437.80	554.10	684.10	827.80	985.10	-	-
32	5.40	21.70	48.80	86.70	135.50	195.10	265.50	346.50	439.00	541.90	655.70	780.40	915.80	-
40	4.70	18.90	42.60	75.80	118.40	170.40	232.00	303.00	383.50	473.50	572.90	681.80	800.20	928.00
50	3.80	15.20	34.10	60.60	94.70	136.40	185.60	242.40	306.80	378.80	458.30	545.40	640.10	742.40
65	3.10	12.50	28.20	50.10	78.20	112.60	153.30	200.30	253.40	312.90	378.60	450.60	528.80	613.30
80	2.60	10.30	23.10	41.10	64.30	92.50	125.90	164.50	208.20	257.00	311.00	370.10	434.40	503.80

Maximum Installed Deflections (Both Ends Restrained)

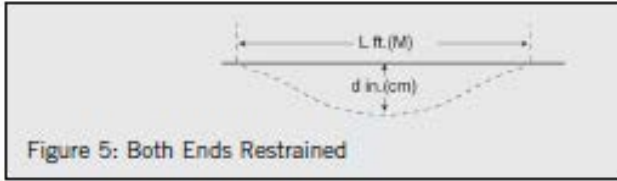

Formula: $d = 0.0823 \frac{L^2}{D}$

Where: d = deflection in inches
 L = length in feet
 D = average outside diameter in inches (ref. Pg. 7)

Example

L = 10 ft.
 D = 2.375" (for 2" pipe)
 $d = 0.0823 \times \frac{10^2}{2.375}$
 $= 0.0823 \times \frac{100}{2.375}$
 $= 3.50$

Pipe Size	Pipe Length in Feet													
Inches	2	5	7	10	12	15	17	20	25	30	35	40	45	50

Permissible Bending Deflections SDR 13.5 (73 °F) in inches

¾	0.30	2.00	3.80	7.80	11.30	17.60	22.60	31.10	49.00	70.50	96.00	125.40	158.70	195.90
1	0.30	1.60	3.10	6.30	9.00	14.10	18.10	25.00	39.10	56.30	76.60	100.10	126.70	156.40
1¼	0.20	1.20	2.40	5.00	7.10	11.20	14.30	19.80	31.00	44.60	60.70	79.30	100.40	123.90
1½	0.20	1.10	2.10	4.30	6.20	9.70	12.50	17.30	37.10	39.00	53.00	69.30	87.70	108.20
2	0.10	0.90	1.70	3.50	5.00	7.80	10.00	13.90	21.60	31.20	42.40	55.40	70.10	86.60
2½	0.10	0.70	1.40	2.90	4.10	6.40	8.30	11.40	17.90	25.80	35.10	45.80	57.90	71.50
3	0.10	0.60	1.20	2.40	3.40	5.30	6.80	9.40	14.70	21.20	28.80	37.60	47.60	58.80

Formula: $d = 57.1528 \frac{L^2}{D}$

Where: d = deflection in cm
 L = length in meters
 D = average outside diameter in mm (ref. Pg. 7)

Example

L = 5 m.
 D = 60.3 mm (for 50 mm pipe)
 $d = 57.1528 \times \frac{5^2}{60.3}$
 $= 57.1528 \times \frac{25}{60.3}$
 $= 23.70$

Pipe Size	Pipe Length in Meters													
mm	1	2	3	4	5	6	7	8	9	10	11	12	13	14

Permissible Bending Deflections SDR 13.5 (23 °C) in cm

20	2.10	8.60	19.30	34.20	53.50	77.10	104.90	137.00	173.40	214.10	259.00	308.20	361.80	419.50
25	1.70	6.80	15.40	27.40	42.80	61.60	83.80	109.50	138.60	171.10	207.10	246.40	289.20	335.40
32	1.40	5.40	12.20	21.70	33.90	48.80	66.40	86.70	109.70	135.40	163.90	195.00	228.90	265.40
40	1.20	4.70	10.60	18.90	29.60	42.60	58.00	75.70	95.80	118.30	143.20	170.40	200.00	231.90
50	0.90	3.80	8.50	15.20	23.70	34.10	46.40	60.70	76.80	94.80	114.70	136.50	160.20	185.80
65	0.80	3.10	7.00	12.50	19.60	28.20	38.40	50.10	63.40	78.30	94.70	112.70	132.30	153.50
80	0.60	2.60	5.80	10.30	16.10	23.10	31.50	41.10	52.10	64.30	77.80	92.60	108.60	126.00

Handling and Installation

BlazeMaster® CPVC by Ashirvad is a tough, corrosion resistant material, but does not have the mechanical strength of steel. Reasonable care must be exercised in handling pipe and fittings. They must not be dropped or have objects dropped on them. If improper handling results in scratches, splits, or gouges, the damaged section shall be cut out and discarded.

BlazeMaster® pipe by Ashirvad must be covered with a nontransparent material when stored out of doors for extended periods of time. Brief exposure to direct sunlight on the job site may result in color fade but will not affect physical properties. BlazeMaster® fittings by Ashirvad should be stored in their original containers to keep them free from dirt and reduce the possibility of damage. Caution should be taken not to overstack boxes of BlazeMaster® fittings by Ashirvad in extreme temperature environments (>150°F).

Underground Water Pressure Service

Both pipe and fittings may be used in underground water pressure service installations as per the following requirements:

1. ASTM D 2774, Standard Recommended Practice for Underground Installation of Thermoplastic Pressure Piping,
2. ASTM F 645, Standard Guide for Selection, Design and Installation of Thermoplastic Water Pressure Piping Systems.
3. The BlazeMaster® CPVC protection pipe and fittings by Ashirvad shall be installed as per the manufacturer's installation instructions and this design manual.

Installation

Thrust Blocking

BlazeMaster® fire protection systems by Ashirvad utilize a solvent cement joining method. As such, thrust blocks are not required with BlazeMaster® CPVC pipe and fittings by Ashirvad in underground water pressure service.

Trenching

The trench should be of adequate width to allow convenient installation, while at the same time being as narrow as possible. Minimum trench widths may be utilized by joining pipe outside of the trench and lowering it into the trench after adequate

joint strength has been achieved. Trench widths will have to be wider where pipe is joined in the trench or where thermal expansion and contraction is a factor. See section titled "Snaking of Pipe".

- Water filled pipe should be buried at least 12" (305 mm) below the maximum expected frost line.
- It is recommended that BlazeMaster® piping by Ashirvad be run within a metal or concrete casing when it is installed beneath surfaces that are subject to heavy-weight or constant traffic such as roadways and railroad tracks.

The trench bottom should be continuous, relatively smooth and free of rocks. Where ledge rock, hardpan or boulders are encountered, it is necessary to protect the pipe from damage. Use a minimum of 4" (102 mm) of clean soil or sand. Crushed stone or other materials may have a negative impact on the performance of the pipe.

Sufficient cover must be maintained to keep external stress levels below acceptable design stress. Reliability and safety of service is of major importance in determining minimum cover. Local, state and national codes may also govern.

Snaking of Pipe

After BlazeMaster® CPVC pipe by Ashirvad has been solvent welded, it is advisable to snake the pipe according to the below recommendations beside the trench during its required curing time. **BE ESPECIALLY CAREFUL NOT TO APPLY ANY STRESS THAT WILL DISTURB THE UNDRIED JOINT.** This snaking is necessary in order to allow for any anticipated thermal movement that could take place in the newly joined pipeline.

Snaking is particularly necessary on the lengths that have been solvent welded during the late afternoon on a hot summer's day, because their drying time will extend through the cool of the night when thermal contraction of the pipe could stress the joints to the point of pull out. This snaking is also especially necessary with pipe that is laid in its trench (necessitating wider trenches than recommended) and is back-filled with cool

Figure 6: Snaking of Pipe

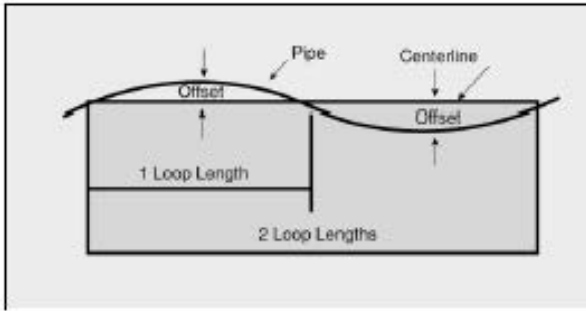

Backfilling

Note: Underground pipe shall be thoroughly inspected and tested for leaks prior to backfilling. Backfill material should be placed over pipe sections only, leaving the joints exposed during testing.

Ideally, backfilling should only be done early in the morning during hot weather when the line is fully contracted and there is no chance of insufficiently dried joints being subjected to contraction stresses.

The pipe should be uniformly and continuously supported over its entire length on firm, stable material. Blocking should not be used to change pipe grade or to intermittently support pipe across excavated sections.

Loop Offset in Inches for Contraction:

Maximum Temperature Variation, °F,
Between Time of Solvent Welding and Final Use

Degrees	Loop Length		
	20 Feet	50 Feet	100 Feet
10°	3	7	13
20°	4	9	18
30°	5	11	22
40°	5	13	26
50°	6	14	29
60°	6	16	32
70°	7	17	35
80°	7	18	37
90°	8	19	40
100°	8	20	42

Loop Offset in mm for Contraction:

Maximum Temperature Variation, °C,
Between Time of Solvent Welding and Final Use

Degrees	Loop Length		
	65.6 Meters	164 Meters	328 Meters
12°	76	178	330
7°	102	229	457
1°	127	279	559
4°	127	330	660
10°	152	356	737
16°	152	406	813
21°	178	432	889
27°	178	457	940
32°	203	483	1016
38°	203	508	1067

Pipe is installed in a wide range of sub-soils. These soils should not only be stable but applied in such a manner to physically shield the pipe from damage. Attention should be given to local pipe laying experience that may indicate particular pipe bedding problems.

Backfill materials free of rocks with a particle size of 1/2" (12.7 mm) or less should be used to surround the pipe with 6" (152 mm) to 8" (203 mm) of cover. It should be placed in layers. Each soil layer should be sufficiently compacted to uniformly develop lateral passive soil forces during the backfill operation. It may be advisable to have the pipe under hydraulic pressure, 15 to 25 psi (103 - 172 kPa) during the backfilling.

Vibratory methods are preferred when compacting sand or gravel. Best results are obtained when the soils are in a nearly saturated condition. Where water flooding is used, the initial backfill should be sufficient to insure complete coverage of the pipe. Additional material should not be added until the water flooded backfill is firm enough to walk on. Care should be taken to avoid floating the pipe. Sand and gravel containing a significant proportion on fine grained material, such as silt and clay, should be compacted by hand or, preferably by mechanical tamper.

The remainder of the backfill should be placed and spread in approximately uniform layers in such a manner to fill the trench completely so that there will be no unfilled spaces under or about the rocks or lumps of earth in the backfill. Large or sharp rocks, frozen clods and other debris greater than 4" (102 mm) in diameter should be removed. Rolling equipment or heavy tampers should only be used to consolidate the final backfill.

The pipe should be sleeved with a compatible sleeving where it penetrates the slab.

Outdoor Installations

Ashirvad BlazeMaster® pipe and fittings by Ashirvad are not for exposed, outdoor applications.

Joining BlazeMaster® Pipe and Fittings by Ashirvad with Red One Step Solvent Cement

Note: BlazeMaster® BM-5 One Step Cement requires no cleaner or primer. Refer to individual manufacturers' installation instructions.

Step 1: Cutting

Ashirvad BlazeMaster® pipe by Ashirvad can be easily cut with a ratchet cutter (except at temperatures below 10°C (50°F)), a wheel type plastic tubing cutter, a power saw or a fine toothed saw. To ensure the pipe is cut square, a miter box is recommended when using a saw. A square cut provides the surface of the pipe with maximum bonding area. If any indication of damage or cracking is evident at the pipe end, cut off at least 50.8 mm (2") beyond any visible crack.



Step 2: Deburring/Beveling

Burrs and filings can prevent proper contact between pipe and fitting during assembly, and must be removed from the outside and the inside of the pipe. A chamfering tool or a file is suitable for this purpose. A slight bevel shall be placed at the end of the pipe to ease entry of the pipe into the socket and minimize the chances of wiping solvent cement from the fitting during insertion. **Fitting Preparation:** Using a clean, dry rag, wipe loose dirt and moisture from the fitting socket and pipe end. Moisture can slow the cure time and at this stage of assembly, excessive water can reduce joint strength. Check the dry fit of the pipe and fitting. The pipe should enter the fitting socket easily 1/4 to 3/4 of the way. At this stage, the pipe should not bottom out in the socket.



Step 3: Solvent Cement Application

Joining surfaces shall be penetrated and softened. Cement shall be applied (worked into pipe) with an applicator half the nominal size of the pipe diameter. Apply a heavy, even coat of cement to the outside pipe end. Apply a medium coat to the fitting socket. Pipe sizes 1 1/4" (32 mm) and above shall always receive a second cement application on the pipe end. (Apply cement on the pipe end, in the fitting socket, and on the pipe again.) Only use solvent cements that have been specifically investigated and tested for use with BlazeMaster® CPVC systems by Ashirvad and approved by the pipe and fitting manufacturer. Too much cement can cause clogged waterways. Do not allow excess cement to puddle in the pipe and fitting assembly. Special care shall be exercised when assembling BlazeMaster® systems in extremely low temperatures (below 4°C (40°F)) or extremely high temperatures (above 38°C (100°F)). Extra set time shall be allowed in colder temperatures.



Step 4: Assembly

After applying solvent cement, immediately insert the pipe into the fitting socket, while rotating the pipe one-quarter turn. Properly align the fitting for the installation at this time. Pipe must bottom to the stop. Hold the assembly for 10 to 15 seconds to ensure initial bonding. A bead of solvent cement should be evident around the pipe and fitting juncture. If this bead is not continuous around the socket shoulder, it may indicate that insufficient cement was applied.

If insufficient cement is applied, the fitting must be cut out and discarded. Cement in excess of the bead can be wiped off with a rag. Care shall be exercised when installing sprinkler heads. Sprinkler head fittings shall be allowed to cure for a minimum of 30 minutes prior to installing the sprinkler head.



When installing sprinkler heads, be sure to anchor or hold the pipe drop securely to avoid rotating the pipe in previously cemented connections. Previously cemented fittings shall also be permitted to cure for a minimum of 30 minutes. Warning: Sprinkler heads shall be installed only after all the CPVC pipe and fittings, including the sprinkler head adapters, are solvent welded to the piping and allowed to cure for a minimum of 30 minutes. Sprinkler head fittings should be visually inspected and probed with a wooden dowel to ensure that the water way and threads

Set and Cure Times

Solvent cement set and cure times are a function of pipe size, temperature, relative humidity, and tightness of fit. Curing time is faster for drier environments, smaller pipe sizes, higher temperatures and tighter fits. The assembly must be allowed to set, without any stress on the joint, for 1 to 5 minutes, depending on pipe size and temperature. Following initial set period, the assembly can be handled carefully, avoiding significant stresses to the joint. Refer to the following tables for minimum cure times prior to pressure testing.

Note: For these sizes, the solvent cement can be applied at temperatures below -17.8°C (0°F), however, the sprinkler system temperature must be raised to a temperature of 0°C (32°F) or above and allowed to cure per the above recommendations prior to pressure testing.



are clear of any excess cement. Once the installation is complete and cured per Table I, II or III, the system shall be hydrostatically tested. Sprinklers shall not be installed in the fittings prior to the fittings being cemented in place.

Note: Safety and Health Precautions. Prior to using CPVC solvent cements, review and follow all precautions found on the container labels, material safety data sheet, and Standard Practice for Safe Handling ASTM F 402.

TABLE I 15.52 kg/cm² (225 psi)
Test Pressure (maximum) Ambient
Temperature During Cure Period

Pipe Size		Temperature		
(inch)	(mm)	16°C to 49°C (60°F to 120°F)	> 4.4°C (> 40°F)	>17.8°C (> 0°F)
¾	20	1 hr	4 hrs	48 hrs
1	25	1½ hrs	4 hrs	48 hrs
1¼ & 1½	32 & 40	3 hrs	32 hrs	10 days
2	50	8 hrs	48 hrs	Note 1
2½ & 3	65 & 80	24 hrs	96 hrs	Note 1

TABLE II 13.79 kg/cm² (200 psi)
Test Pressure (maximum) Ambient
Temperature During Cure Period

Pipe Size		Temperature		
(inch)	(mm)	16°C to 49°C (60°F to 120°F)	> 4.4°C (> 40°F)	>17.8°C (> 0°F)
¾	20	45 mins	1½ hrs	24 hrs
1	25	45 mins	1½ hrs	24 hrs
1¼ & 1½	32 & 40	1½ hrs	16 hrs	120 days
2	50	6 hrs	36 hrs	Note 1
2½ & 3	65 & 80	8 hrs	72 hrs	Note 1

TABLE III 6.9 kg/cm² (100 psi)
Test Pressure (maximum) Ambient
Temperature During Cure Period

Pipe Size		Temperature		
(inch)	(mm)	16°C to 49°C (60°F to 120°F)	> 4.4°C (> 40°F)	>17.8°C (> 0°F)
¾	20	15 mins	15 mins	30 mins
1	25	15 mins	30 mins	30 mins
1¼ & 1½	32 & 40	15 mins	30 mins	2 hrs

Estimating One-Step Solvent Cement Requirements

The following guidelines are provided to allow estimation of one-step solvent cement quantities needed.

Fitting Size		Number of Joints Per Quart	Number of Joints Per Liter
inches	mm		
¾	20	270	285
1	25	180	190
1¼	32	130	137
1½	40	100	106
2	50	70	74
2½	65	50	53
3	80	40	42

Hangers and Supports

Because BlazeMaster® pipe by Ashirvad is rigid, it requires fewer supports than flexible plastic systems. The support spacing is shown in the following table.

Most hangers designed for metal pipe are suitable for BlazeMaster® pipe by Ashirvad. Do not use undersized hangers. Hangers with sufficient load bearing surface shall be selected based on pipe size, i.e., 40 mm hangers for 40 mm pipe. The hanger shall not have rough or sharp edges that come in contact with the pipe.

Nominal Size		Maximum Support Spacing	
inches	mm	feet	meters
¾	20	5½	1.67
1	25	6	1.83
1¼	32	6½	1.98
1½	40	7	2.13
2	50	8	2.43
2½	65	9	2.74
3	80	10	3.05

When a sprinkler head activates, a significant reactive force can be exerted on the pipe. With a pendent head, this reactive force can cause the pipe to lift vertically if it is not properly secured, especially if the sprinkler drop is from small diameter pipe. The closest hanger shall brace the pipe against vertical lift-up.

TABLE A: Maximum Support Spacing Distance In Line Sprinkler Head Drop Tee

Nominal Pipe Size		Less than 690 kPa (100psi)		More than 690 kPa (100psi)	
inches	mm	feet	meters	feet	meters
¾	20	4	1.22	3	0.91
1	25	5	1.52	4	1.22
1¼	32	6	1.83	5	1.52
1½ - 3	40 - 80	7	2.13	7	2.13

TABLE B: Maximum Support Spacing Distance End Line Sprinkler Head Drop Elbow

Nominal Pipe Size		Less than 690 kPa (100psi)		More than 690 kPa (100psi)	
inches	mm	feet	meters	feet	meters
¾	20	9	228.60	6	152.40
1	25	12	304.80	9	228.60
1¼	32	16	406.40	12	304.80
1½ - 3	40 - 80	24	609.60	12	304.80

The closest hanger shall brace the pipe against vertical liftup. Any of a number of techniques can be used to brace the pipe. Four acceptable approaches would be to use a standard band hanger positioning the threaded support rod to 1.588 mm (1/16") above the pipe, a split-ring hanger, a wrap-around U hanger, or a special escutcheon which prevents upward movement of the sprinkler through the ceiling.

Figure 7: Support Spacing Drop Elbow and Drop Tee

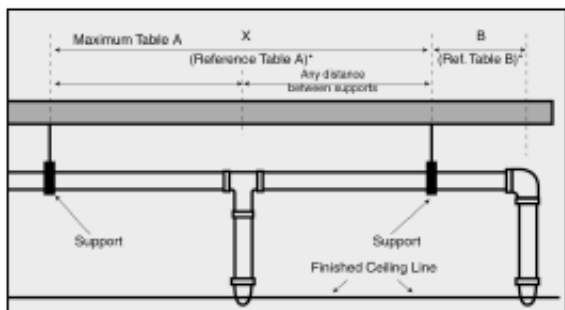

Penetration of Studs and Joists

Wooden Studs and Joists

It is acceptable to cut holes in wood studs for support. The holes should be oversized to allow for movement.

Metal Studs

BlazeMaster® pipe by Ashirvad and fittings should be protected from sharp edges when passing through metal studs.

Transition to Other Materials

Support

Additional support should be added at the metal side of a BlazeMaster® CPVC-metal by Ashirvad transition to support the weight of the metal system.

Threaded Connections

BlazeMaster® CPVC by Ashirvad female threaded adapters or flanges for connecting to other materials, valves, and appurtenances.

A thread sealant shall be used in making threaded connections. TFE (Teflon®) thread tape is the recommended sealant. Some thread sealants other than TFE thread tape contain solvents or other materials that may be damaging to CPVC. Contact your authorized BlazeMaster® by Ashirvad distributor or Ashirvad Representative for approved thread sealants. Use of thread sealants other than those approved by Ashirvad will void the warranty on the BlazeMaster® system by Ashirvad.

Care shall be exercised when transitioning between BlazeMaster® pipe and fittings by Ashirvad and metal. Care must be taken to avoid over-torquing. Refer to section on instructions for torque requirements.

The following is the recommended method of installation to ensure a sound connection.

- Begin by applying 2 to 3 wraps of TFE (Teflon®) thread tape.
- Tighten the sprinkler head into the adapter taking care not to cross-thread the fitting. (Recommended torque values 15-25 ft/lbs)
- Two to three turns beyond finger-tight is all that is required to make a sound plastic threaded connection.

CAUTION: Over-tightening will damage both the pipe and the fitting.

Flanged Connections

Flange Make-Up: Once a flange is joined to pipe, the method for joining two flanges is as follows:

- Piping runs joined to the flanges must be installed in a straight line position to the flange to avoid stress at the flange due to misalignment. Piping must also be secured and supported to prevent lateral movement that can create stress and damage the flange.
- With gasket in place, align the bolt holes of the mating flanges by rotating the ring into position. (Consideration should be given to alignment of One- Piece Flange prior to joining with pipe.)
- Insert all bolts, washers (two standard flat washers per bolt), and nuts.
- Make sure the faces of the mating surfaces are flush against gasket prior to bolting down the flanges.
- Tighten the nuts by hand until they are snug. Establish uniform pressure over the flange face by tightening the bolts in 5 ft. lb. (6.8 M Kg) increments according to the sequence shown in Figure 8: Bolt Tightening Sequence following a 180° opposing sequence.
- Care must be taken to avoid “bending” the flange when joining a flange to a “raised face” flange, or a wafer-style valve. Do not use bolts to bring together improperly mated flanges.

CAUTION: Over-torquing will damage the flange. Torque given is for dry, non-lubricated bolt, standard washers, neoprene 3.18 mm (1/8²) thick full face gasket. If lubricant (non-petroleum based) is used, torque levels may vary. Actual field conditions may require a variation in these recommendations.

Recommended Bolt Torque

Flange size		Bolt Diameter		Torque	
inches	mm	inches	mm	ft lbs	M Kg
¾ - 1½	19.05 - 38.10	½	12.70	10 - 15	13.6 - 20.3
2 - 3	50.80 - 76.20	¾	15.88	20 - 30	27.1 - 40.7

Figure 8: Bolt Tightening Sequence

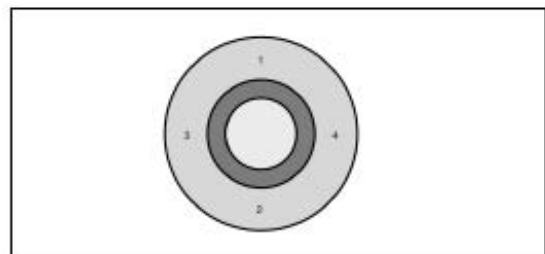

Grooved Coupling Adapters

The following procedures are recommended for proper assembly of the Grooved Coupling Adapter. READ THESE INSTRUCTIONS CAREFULLY BEFORE BEGINNING INSTALLATION.

1. Inspect the fittings and pipe to insure that they are sufficiently free from indentations, projections or rollmarks on the gasket seating areas of the fitting and pipe. The pipe should be squarely cut with any loose scale, paint and/or dirt must be removed from the groove and seating surface. Use a standard grade E*, EPDM compound that is suitable for wet fire sprinkler service. A flexible coupling shall be used with grooved coupling adapters. Caution: Use of rigid style couplings may damage the grooved coupling adapter. Consult the coupling manufacturer for proper selection.

*See manufacturer for temperature ratings.

2. Make sure the gasket is clean and free of any cracks, cuts or other defects which may cause leaks. Lubricate the gasket with a vegetable soap-based gasket lubricant. Caution: Use of petroleum based lubricants will damage the gasket and adapter resulting in stress failure of the CPVC adapter. A gasket/joint lubricant is recommended to prevent pinching the gasket and to assist in seating the gasket during the alignment process. Apply the appropriate lubricant to the gasket lips and exterior surface of the gasket.
3. Place the gasket over the metal pipe ends, being sure gasket lip does not overhang the pipe end. Insert the CPVC grooved coupling adapter into the gasket. Make sure that the gasket is centered between the two grooves. No portion of the gasket should extend into the grooves. Caution: Make sure the gasket is not pinched between the pipe and the fitting.
4. Place the metal housing over the gasket, making sure the metal housing key is into the grooves on the metal pipe and the CPVC coupling adapter. Insert the bolts and tighten by hand. Tighten the bolts alternately and equally until the bolt pads are touching metal-to-metal. In completing a proper joint, the gasket is also slightly compressed, adding to the strength of the seal from the gasket's durometer.
5. Inspect the joints before and after pressure testing. Look for gaps between the bolt pads and for housing keys that are not inside the grooves.

Penetrating Fire Rated Walls & Partitions

Before penetrating fire rated walls and partitions, consult building codes and authorities having jurisdiction in your area. Several classified through-penetration fire stop systems are approved for use with CPVC pipe. Consult Ashirvad representative for further information. Warning: Some fire stop sealants or wrap strips contain solvents or plasticizers that may be damaging to CPVC. Always consult the manufacturer of the firestop material for compatibility with BlazeMaster® CPVC pipe and fittings by Ashirvad.

Earthquake Bracing

Since BlazeMaster® CPVC pipe by Ashirvad is more ductile than metallic sprinkler pipe, it has a greater capacity to withstand earthquake damage. When it is required to earthquake brace BlazeMaster® piping, it is important to use fittings, fasteners or clamps that do not have sharp edges or apply excessive compressive forces sufficient to distort the pipe.

Sway Bracing Guidance for CPVC

Sway bracing for BlazeMaster® CPVC by Ashirvad shall be designed and installed per NFPA 13. Compressive load shall not be placed on CPVC pipe. Many common longitudinal sway braces exert compressive load on the pipe through a clamp and shall not be used with CPVC products. In order to avoid this, the installer should use lateral sway braces designed for use with CPVC pipe in one of the following manners. In accordance with NFPA 13, a lateral sway brace may be used as a longitudinal brace if they are within 24" (610 mm) of the centerline of the piping to be braced longitudinally and the lateral brace is on a pipe of equal or greater size than the pipe being braced longitudinally. If a line of equal or greater size isn't available in the location of longitudinal bracing, a dead leg may be installed. This dead leg may be used to longitudinally brace a line with a lateral brace. Follow the procedure below to install and brace a dead leg.

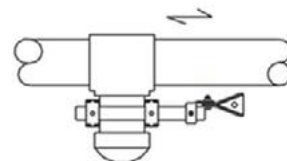

1. Install a tee in the main or cross main at the point where longitudinal bracing is required.
2. Cut a length of pipe with a diameter equal to or greater than the diameter of the main being longitudinally braced.
3. Cap one end of the pipe using proper solvent welding technique. (See section on "Joining CPVC Pipe and Fittings with One-Step Solvent Cement.")
4. Solvent weld the pipe to the tee perpendicular to the main being longitudinally braced.
5. Attach a lateral sway brace designed for use with CPVC pipe to the dead leg. The sway brace must be no greater than 24" (610 mm) from the center line of the main.

Installation Dos and Dont's

While not a complete list, the following is intended to highlight many of the “Do’s” and “Dont’s” to be followed for BlazeMaster® products.

Do's

- Install product according to the manufacturer's installation instructions and technical manual.
- Follow recommended safe work practices.
- Make certain that thread sealants, gasket lubricants, or fire stop materials are compatible with BlazeMaster® CPVC pipe and fittings by Ashirvad.
- Use only latex-based paints if painting is permitted.
- Keep pipe and fittings in original packaging until needed.
- Cover pipe and fittings with an opaque tarp if stored out Doors.
- Follow proper handling procedures.
- Use tools specifically designed for use with plastic pipe and fittings.
- Use proper solvent cement and follow application Instructions.
- Use a drop cloth to protect interior finishes.
- Cut the pipe ends square.
- Deburr and bevel the pipe end before solvent cementing.
- Rotate the pipe one-quarter turn when bottoming pipe in fitting socket.
- Avoid puddling of solvent cement in fittings and pipe.
- Follow the manufacturer's recommended cure times prior to pressure testing.
- Fill lines with water slowly and bleed the air from the system prior to pressure testing.
- Support sprinkler head properly to prevent lift up of the head through the ceiling when activated.
- Keep threaded rod within 1.588 Mm (1/16”) of the pipe.
- Install Ashirvad CPVC fire protection systems in wet systems only.
- Use only insulation and/or glycerin & water solutions for freeze protection.
- Allow for movement due to expansion and contraction.
- Review your fire protection Installation training every two years.

Dont's

- Do not use edible oils such as crisco® as a gasket lubricant.
- Do not use petroleum or solvent-based paints, sealants, lubricants or fire stop materials.
- Do not use any glycol-based solutions as an anti-freeze.
- Do not mix glycerin and water solution in contaminated containers.
- Do not use both teflon® tape and thread sealants simultaneously.
- Do not use solvent cement that exceeds its shelf life or has become discolored or gelled.
- Do not allow solvent cement to plug the sprinkler head orifice.
- Do not connect rigid metal couplers to grooved adapters.
- Do not thread, groove, or drill pipe.
- Do not use solvent cement near sources of heat, open flame, or when smoking.
- Do not pressure test until recommended cure times are met.
- Do not use dull or broken cutting tool blades when cutting pipe.
- Do not use pipe that has been stored outdoors, unprotected and is faded in color.
- Do not allow threaded rod to come in contact with the pipe.
- Do not install in cold weather without allowing for expansion.
- Do not install BlazeMaster® CPVC pipe and fittings by Ashirvad in dry systems.
- Do not allow solvent cement to run and plug the sprinkler head orifice.
- Do not pressure test with air or compressed gas.

Fittings - Dimensions

ELBOW 90°

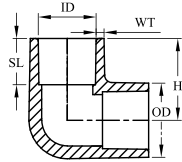

SIZE	ID	WT	SL	H
¾"	26.87	4.00	25.65	41.44
1"	33.66	4.64	28.83	47.79
1¼"	42.42	4.94	32.00	55.72
1½"	48.56	5.17	35.18	62.08
2"	60.63	5.64	38.35	71.60
2½"	73.38	7.58	45.45	84.45
3"	89.31	8.62	48.30	98.35

SIZE	ID	WT	SL	L	H
¾"	26.86	4.0	25.65	40.5	81.0
1"	33.64	4.64	28.83	47.3	94.6
1¼"	42.42	4.95	32.0	54.1	108.2
1½"	48.56	5.18	35.18	60.8	121.6
2"	60.63	5.63	38.35	70.90	141.80
2½"	73.38	8.06	44.80	86.90	173.80
3"	89.31	8.74	47.8	99.90	199.80

ELBOW 45°

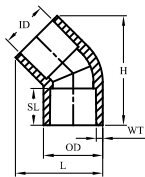

SIZE	ID	WT	SL	L	H
¾"	26.87	4.01	25.65	53.53	69.68
1"	33.65	4.65	28.83	63.72	80.52
1¼"	42.42	4.95	32.00	75.08	91.95
1½"	48.56	5.18	35.18	84.08	102.41
2"	60.63	5.64	38.35	99.73	118.00
2½"	73.38	7.31	46.70	127.73	157.70
3"	89.31	7.74	50.00	147.89	177.10

CROSS TEE

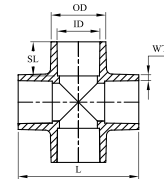

SIZE	ID	WT	SL	L
¾"	26.87	3.91	25.50	79.00
1"	33.66	4.65	28.80	91.50

COUPLER

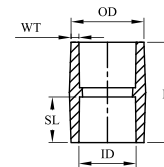

SIZE	ID	WT	SL	L
¾"	26.87	4.01	25.60	53.58
1"	33.66	4.65	28.78	59.94
1¼"	42.42	4.95	31.95	66.18
1½"	48.56	5.18	35.13	72.64
2"	60.63	5.64	38.30	79.20
2½"	73.38	8.20	46.10	97.00
3"	89.31	9.00	49.00	102.50

TEE

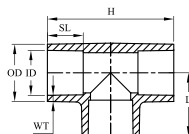

END CAP

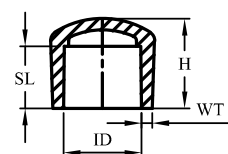

The following notation (symbols) shall apply in this reference manual.

L - Length
W - Width
H - Height

T - Thickness
U - No. of holes
SL - Socket Length

ID - Inner Diameter
OD - Outer Diameter
WT - Wall Thickness

SIZE	ID	WT	SL	H
¾"	26.87	4.01	25.80	32.56
1"	33.66	4.65	28.84	37.20
1¼"	42.42	4.95	32.56	42.20
1½"	48.56	5.18	35.89	46.00
2"	60.63	5.64	41.04	53.40
2½"	73.38	7.30	45.00	62.00
3"	89.31	8.00	48.50	67.00

UNION

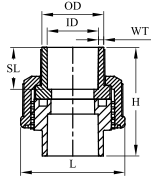

SIZE	ID	WT	SL	L	H
¾"	26.87	3.94	26.40	55.60	68.40
1"	33.66	4.87	28.58	69.00	66.20
1¼"	42.42	4.97	32.90	71.50	84.70
1½"	48.56	5.11	35.70	94.80	86.50
2"	60.63	5.54	38.40	116.40	93.50

ELBOW 90° (BRASS)

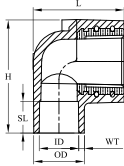

SIZE	ID	WT	SL	L	H
¾ x ½"	26.87	4.22	26.50	41.35	58.60
1 x ½"	33.66	4.61	29.10	41.40	63.20
1 x ¾"	33.66	4.66	29.00	46.85	68.60

TEE (BRASS)

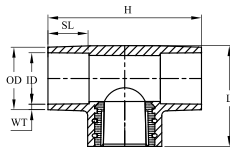

SIZE	ID	WT	SL	L	H
¾ x ¾ x ½"	26.87	4.07	26.00	34.65	84.80
1 x 1 x ½"	33.66	4.56	28.80	37.75	94.40
1 x 1 x 1"	33.66	4.56	29.00	42.00	101.50

FEMALE ADAPTER BRASS THREADED - FABT

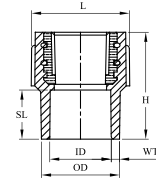

SIZE	ID	WT	SL	H	L
¾"	26.87	3.92	26.20	46.80	42.92
1"	33.66	4.61	29.50	55.50	54.11
1¼"	42.42	4.85	32.10	61.10	63.59
1½"	48.56	5.16	35.50	68.00	70.22
2"	60.63	5.54	38.10	73.90	84.72

REDUCING FEMALE ADAPTER BRASS THREADED

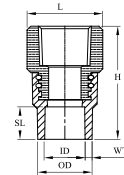

SIZE	ID	WT	SL	L	H
¾ x ½"	26.87	3.94	26.00	37.61	46.20
1 x ½"	33.66	4.66	30.50	43.10	51.50
1 x ¾"	33.66	4.55	29.50	42.88	50.30

FLANGE - END CAP OPEN (WITH RUBBER GASKET)

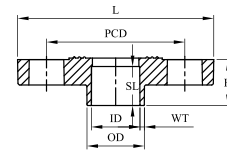

SIZE	ID	WT	SL	L	H	PCD
1"	33.66	4.61	28.70	114.80	34.10	
1¼"	42.42	4.88	32.50	125.70	38.70	
1½"	48.56	5.09	35.10	135.90	4.07	
2½"	73.38	8.17	45.10	177.10	50.50	
3"	89.31	8.40	49.10	190.30	55.70	

REDUCER TEE

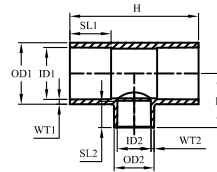

SIZE	ID-1	WT-1	SL-1	ID-2	WT-2	SL-2	L	H
1 x 1 x 3/4"	33.66	4.65	28.88	26.86	4.01	25.67	49.7	92.08
1 1/4 x 1 1/4 x 3/4"	42.42	4.95	31.80	26.87	4.01	25.50	46.90	107.6
1 1/4 x 1 1/4 x 1"	42.42	4.95	31.8	33.66	4.60	28.80	50.55	108.10
1 1/2 x 1 1/2 x 3/4"	48.56	5.18	35.13	26.87	4.01	25.60	50.80	117.06
1 1/2 x 1 1/2 x 1"	48.56	5.18	35.13	33.66	4.65	28.73	54.13	117.06
1 1/2 x 1 1/2 x 1 1/4"	48.56	5.18	35.13	42.42	4.95	31.95	57.35	117.06
2 x 2 x 3/4"	60.63	5.64	38.20	26.87	4.01	25.80	57.20	135.80
2 x 2 x 1"	60.63	5.64	38.20	33.66	4.65	28.60	60.50	135.80
2 x 2 x 1 1/2"	60.63	5.64	38.20	48.56	5.18	35.20	66.80	136.00
3 x 3 x 2"	89.31	8.12	48.63	60.78	5.55	44.00	95.45	181.12
3 x 3 x 2 1/2"	89.31	8.12	48.63	73.38	7.58	45.45	95.45	181.11

BUSHING

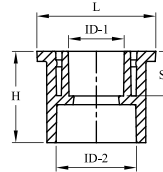

SIZE	ID-1	ID-2	SL-1	SL-2	H	L
1 x 3/4"	26.87	33.40	25.70	29.10	31.48	42.80
1 1/4 x 3/4"	26.87	42.16	26.20	32.00	36.00	52.10
1 1/4 x 1"	33.66	42.16	29.80	32.00	36.00	52.10
1 1/2 x 3/4"	26.87	48.20	26.50	35.50	39.50	58.70
1 1/2 x 1"	33.66	48.20	29.60	35.50	39.50	58.70
1 1/2 x 1 1/4"	42.42	48.20	32.80	36.00	40.00	58.70
2 x 3/4"	26.87	60.32	25.70	38.60	43.60	72.60
2 x 1"	33.66	60.32	28.88	38.60	43.60	72.60
2 x 1 1/4"	42.42	60.32	32.05	38.60	43.60	72.60
2 x 1 1/2"	48.56	60.32	35.23	38.60	43.60	72.60
2 1/2 x 2"	60.63	73.00	38.90	44.70	52.70	87.70
3 x 2"	60.63	88.90	38.20	49.20	56.70	107.00
3 x 2 1/2"	73.38	88.90	45.50	48.40	56.60	98.70

Warranty and Incompatibility

Note on incompatibility

The following items are generally deemed incompatible with BlazeMaster® CPVC pipes and fittings by Ashirvad as they can lead to environmental stress cracking or premature failure of the system. These materials are thus not to be used with BlazeMaster® CPVC pipes and fittings by Ashirvad.

1. Aggressive chemical agents
2. Fire stopping systems
3. Thread sealants
4. Insulation materials with phthalate plasticiser
5. Vaseline
6. Roofing tar
7. Silicone pipe sealants
8. Peppermint oil
9. Vegetable oil
10. Lubricants such as WD40
11. Insecticides
12. Leak detectors
13. Dioctyl phthalate (instead use foam polyethylene)
14. Liquid adhesive
15. PVC pipe wrap tape
16. Acrylic latex caoul and silicone
17. Tiles and all purpose adhesive caulk

Limitation of Liability

USE OF THIS MANUAL OR ANY INFORMATION IT CONTAINS IS AT THE SOLE RISK OF THE USER. Under no circumstances will Ashirvad be liable to any party for any direct, indirect, special incidental, consequential or other damages based on any use of this Manual including, without limitation, any lost profits or business interruption, even if Ashirvad has been specifically advised of the possibility of such damages.

Limitation of Liability

This Manual and all of the information it contains are provided “as is” without warranty of any kind, whether express or implied. It may contain generalizations, technical inaccuracies, or typographical errors. Ashirvad DISCLAIMS ALL WARRANTIES, EXPRESS OR IMPLIED, INCLUDING, WITHOUT LIMITATION, THE IMPLIED WARRANTIES OF MERCHANTABILITY AND FITNESS FOR A PARTICULAR PURPOSE, AND ANY WARRANTY OF NONINFRINGEMENT.

No rights or license.

Information provided herein is for the convenience of users of BlazeMaster®, fire protection systems and is not being published for commercial use. No rights are granted to users in any Ashirvad trademarks, copyrights or other intellectual property or technical data.

Reference Tables and Conversion Charts

TABLE A - WEIGHTS OF WATER

Units of Volume	Pounds	Kilograms
1 US Gallon	8.350	3.791
1 Imperial Gallon	10.020	4.549
1 litre	2.210	1.003
1 cubic yard	1,685.610	765.267
1 cubic foot	62.430	28.343
1 cubic inch	0.036	0.016
1 cubic cm	0.002	0.001
1 cubic metre	2,210.000	1,000.000

TABLE B - VOLUME CONVERSION

Units of Volume	in ³	ft ³	yd ³	cm ³	m ³	liter	U.S. gal.	Imp. gal.
cubic inch	1	0.00058	-	16.387	-	0.0164	0.0043	0.0036
cubic foot	1728	1	0.0370	28,317.8	0.0283	28.32	7.481	6.229
cubic yard	46,656	27	1	-	0.7646	764.55	201.97	168.8
cubic centimeter	0.0610	-	-	1	-	0.001	0.0003	0.0002
cubic meter	61,023.7	35.31	1.308	-	1	1000	264.17	220.0
liter	61.02	0.0353	0.0013	1000	0.001	1	0.2642	0.22
U.S. gallon	231	0.1337	0.0050	3785.4	0.0038	3.785	1	0.8327
Imp. gallon	277.42	0.1605	0.0059	4546.1	0.0045	4.546	1.201	1

TABLE C - TEMPERATURE CONVERSION

Degrees Celsius °C = $\frac{5}{9} (°F - 32)$	Degrees Fahrenheit °F = $\frac{9}{5} °C + 32$
Degrees Kelvin °K = °C + 273.2	Degrees Rankine °R = °F + 459.7

TABLE D - LENGTH CONVERSION

Units of Volume	in	ft	yd	mile	mm	cm	m	km
inch	1	0.0833	0.0278	-	25.4	2.54	0.0254	-
foot	12	1	0.3333	-	304.8	30.48	0.3048	-
yard	36	3	1	-	914.4	91.44	0.9144	-
mile	-	5280	1760	1	-	-	1609.3	1.609
millimeter	0.0394	0.0033	-	-	1	0.100	0.001	-
centimeter	0.3937	0.0328	0.0109	-	10	1	0.01	-
meter	39.37	3.281	1.094	-	1000	100	1	0.001
kilometer	-	3281	1094	0.6214	-	-	1000	1

(1 micron = 0.001 millimeter)

TM & PATENT: Any unauthorized use, copying, manufacturing etc. of the similar product or technology of the invention protected will attract legal actions including, imprisonment or fine under relevant IP laws • Printed in 2020 • All rights reserved. No part of this publication may be copied, modified, reproduced in any material form (including photocopying or storing it in any medium by electronic means and whether or not transiently or incidentally to some other use of this publication) without the written permission of the copyright owner. Applications for the copyright owner's written permission to reproduce any part of this publication should be addressed to the copyright owner. **Warning:** The doing of an unauthorized act in relation to a copyright work may result in both a civil claim for damages and criminal prosecution. **Disclaimer:** Due care and diligence has been taken while editing and printing the book. Neither the author nor the publishers of the book hold any responsibility for any mistake that may have inadvertently crept in. Publishers shall not be liable for any direct, consequential, or incidental damages arising out of the use of the book. In case of binding mistake, misprints, or for missing pages etc. • Printed and bound in India. Moral Rights of the Author are asserted • The copyright owner reserves all rights and liberty to modify, change or alter the design drawings of the products as and when it deems appropriate and necessary without any prior notice to the users.

All rights reserved copyright © 2020 Ashirvad Pipes Private Limited

Ashirvad Pipes Pvt. Ltd., 4-B, Attibele Industrial Area, Hosur Road, Bengaluru - 562 107, Karnataka, INDIA.

T: +91 80 2806 1000 / 2806 1700 **F:** +91 80 2806 1080

For any Service / Customer complaint / Queries:

Toll Free: 1800 572 8900 **M:** +91 9902 333 333 **E:** customercare@ashirvad.com

SMART WATER MANAGEMENT PLUMBING . SANITARY . AGRICULTURE



by **alixis**



www.ashirvad.com